

## INSTRUKCJA MONTAŻU

INSTALLATION INSTRUCTION

Wydanie <i>Edition</i>	01
Data <i>Date</i>	2024-07-20

### ZESTAW AVENIR

AVENIR SET

Numer katalogowy  
*catalogue number* **72502**













#### 1. Informacje techniczne

*Technical information*

Grupa wiekowa <i>User age</i>	do 14 lat <i>up to 14 y.o.</i>
Maksymalna wysokość swobodnego upadku <i>Max. free fall height</i>	0,97 m
Największa część <i>Largest part</i>	Zjeżdżalnia <i>Slide</i>
Wymiary największej części <i>Largest part dimensions</i>	2,3 x 1,2 x 0,55 m
Masa największej części <i>Largest part weight</i>	55 kg
Masa największego fundamentu <i>Largest foundation weight</i>	60 kg
Zgodność z normami <i>Accordance with standards</i>	EN 1176-1 EN 1176-3

## 2. Wykaz narzędzi

### Tools list

## 3. Fundamenty i powierzchnia zderzenia

### Foundations and impact area



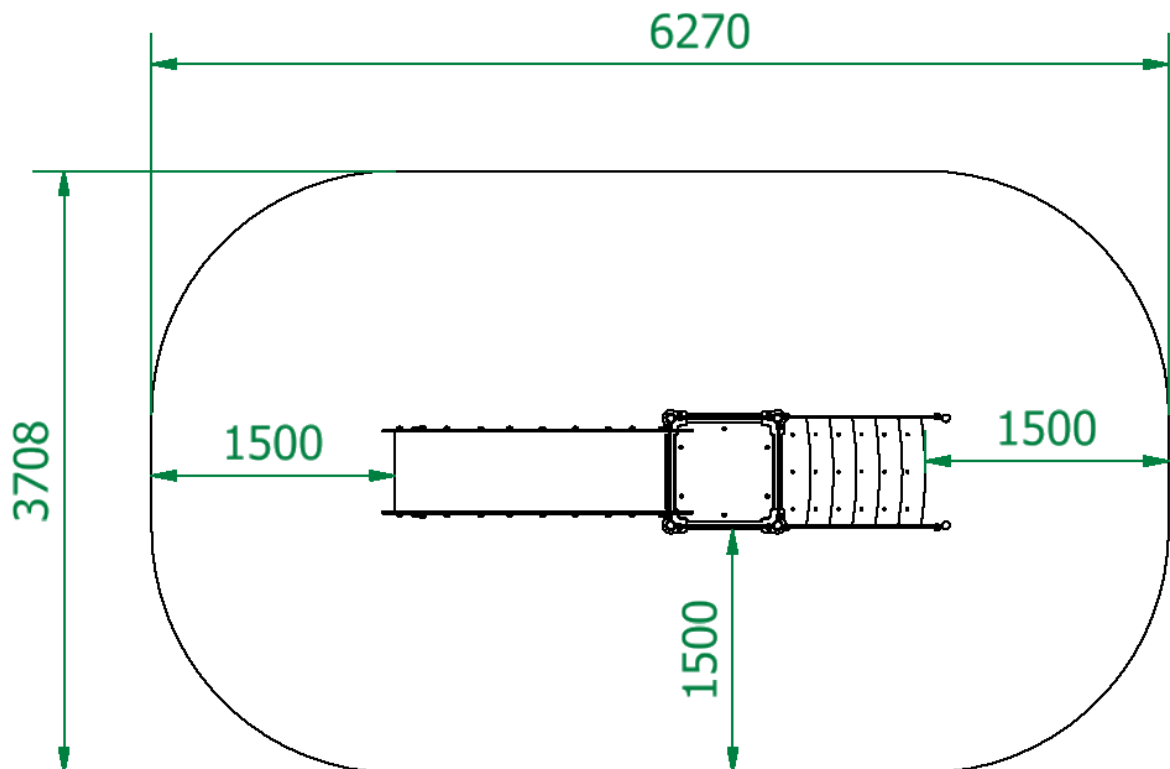

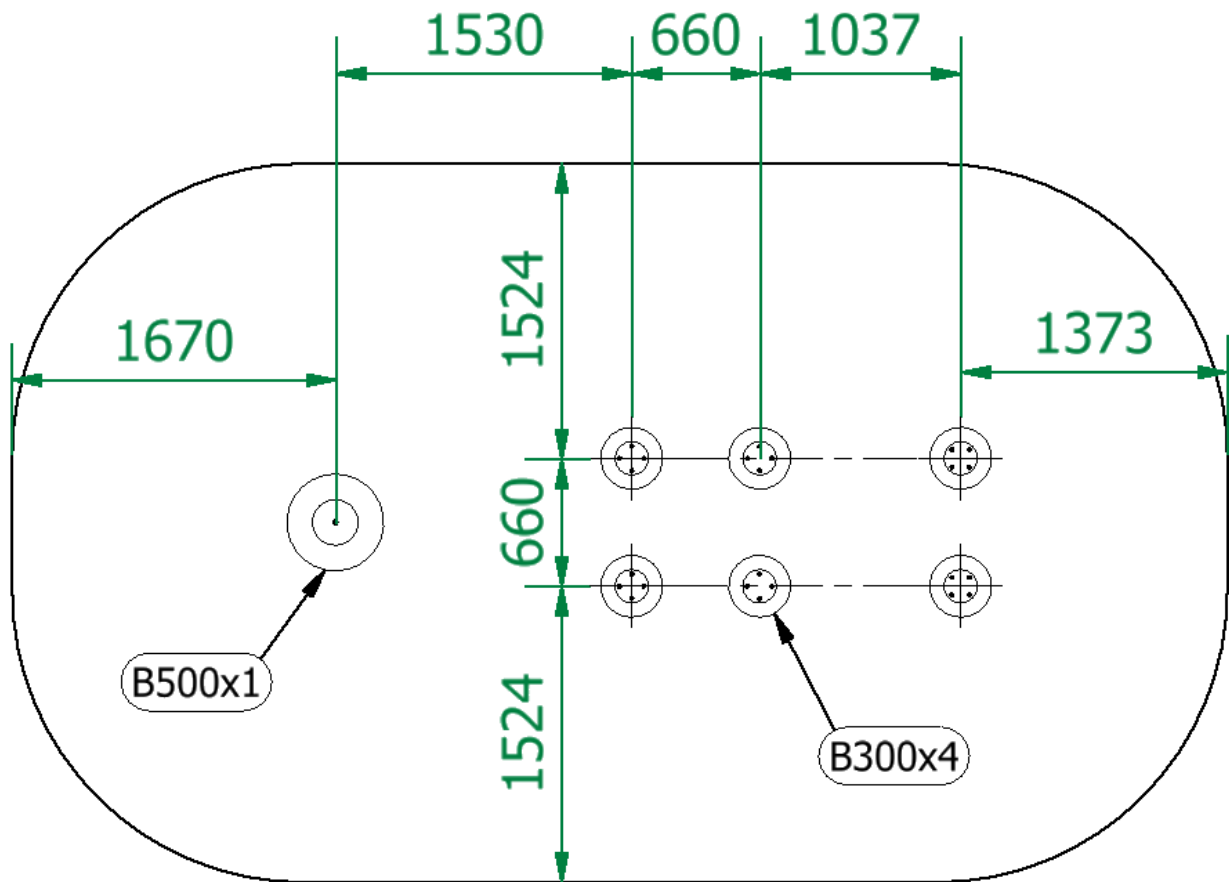
NUMER/NUMBER	SZT./PCS
B500x1	1
B300x4	6

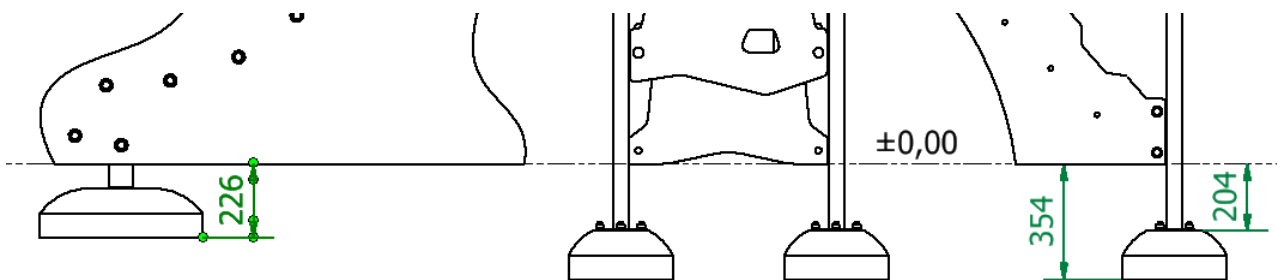

**4. Wieża**  
*Tower*

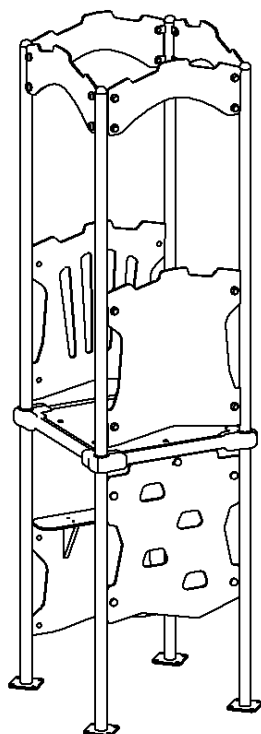

**5. Podzespoły**  
*Components*

