

Wydanie <i>Edition</i>	01
Data <i>Date</i>	2024-12-20

ZESTAW AVENIR *AVENIR SET*

Numer katalogowy
catalogue number **72509**













1. Informacje techniczne *Technical information*

Grupa wiekowa <i>User age</i>	3-14 lat
Maksymalna wysokość swobodnego upadku <i>Max. free fall height</i>	1,11 m
Największa część <i>Largest part</i>	Zjeżdżalnia <i>Slide</i>
Wymiary największej części <i>Largest part dimensions</i>	2,3 x 1,2 x 0,55 m
Masa największej części <i>Largest part weight</i>	55 kg
Masa największego fundamentu <i>Largest foundation weight</i>	60 kg
Zgodność z normami <i>Accordance with standards</i>	EN 1176-1 EN 1176-3

2. Wykaz narzędzi

Tools list

3. Fundamenty i powierzchnia zderzenia

Foundations and impact area



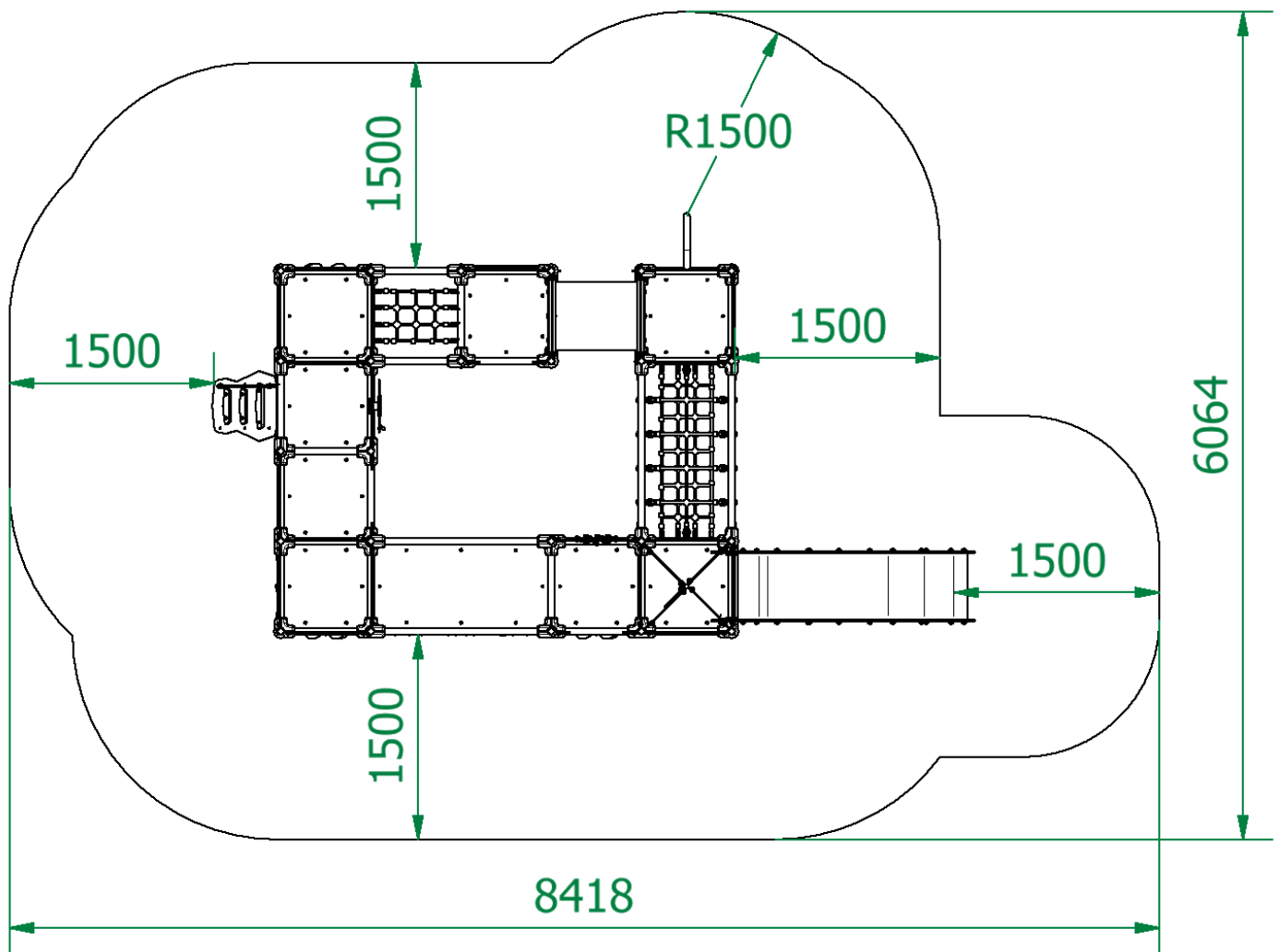

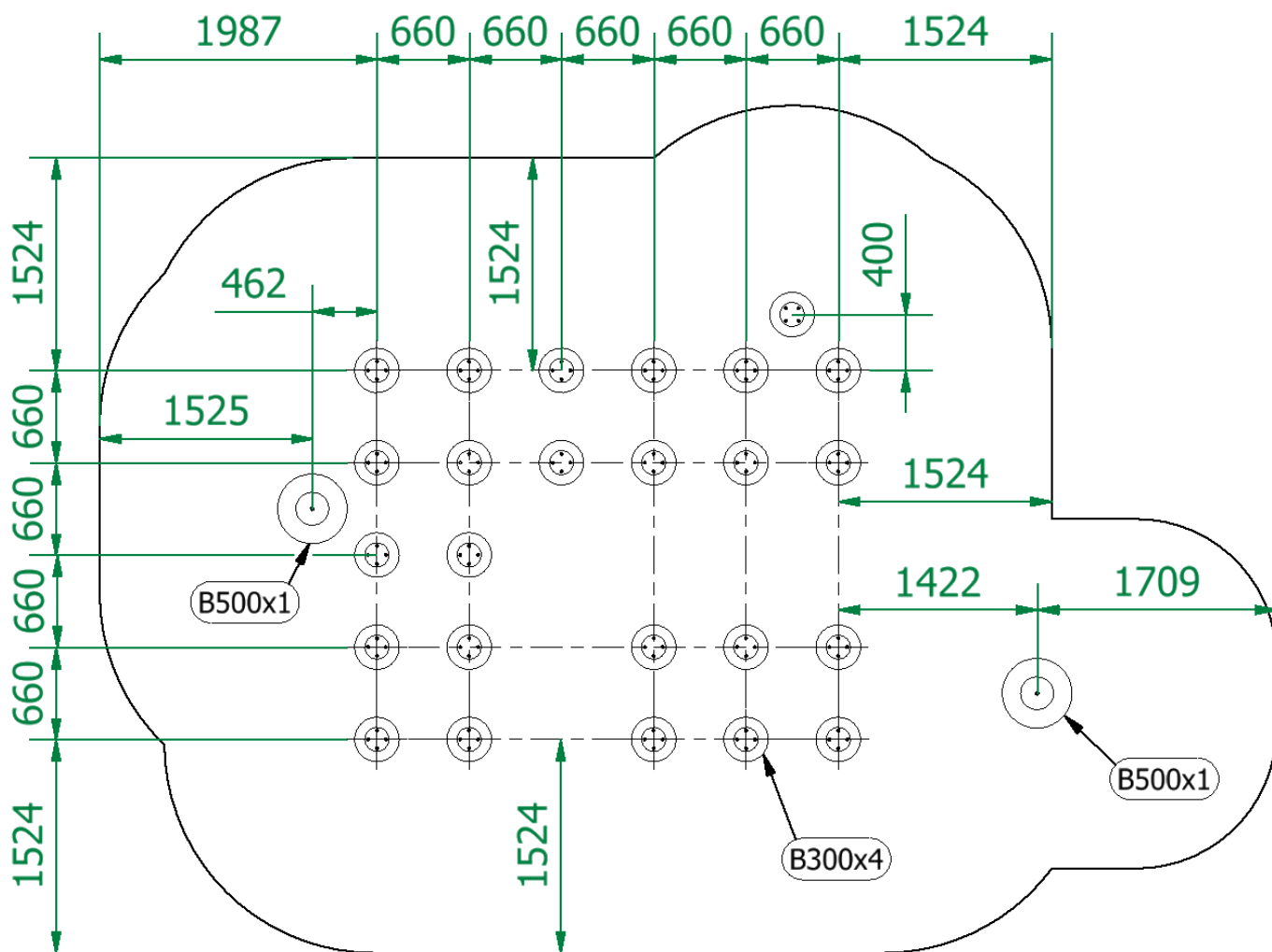
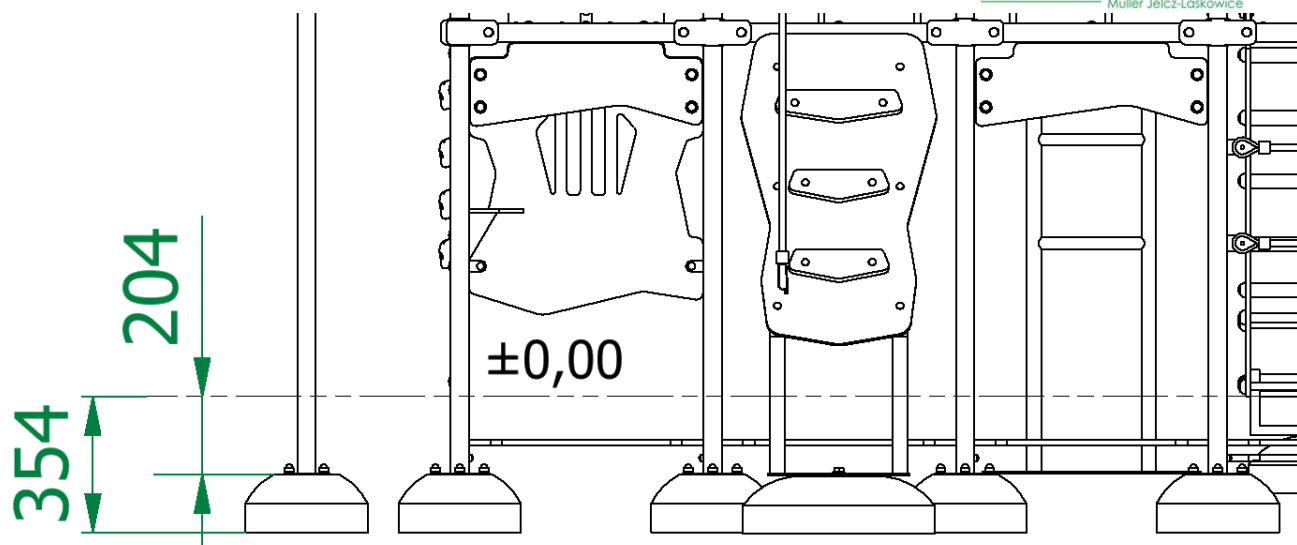
NUMER/NUMBER	SZT./PCS
B500x1	2
B300x4	25

4. Wieże Towers

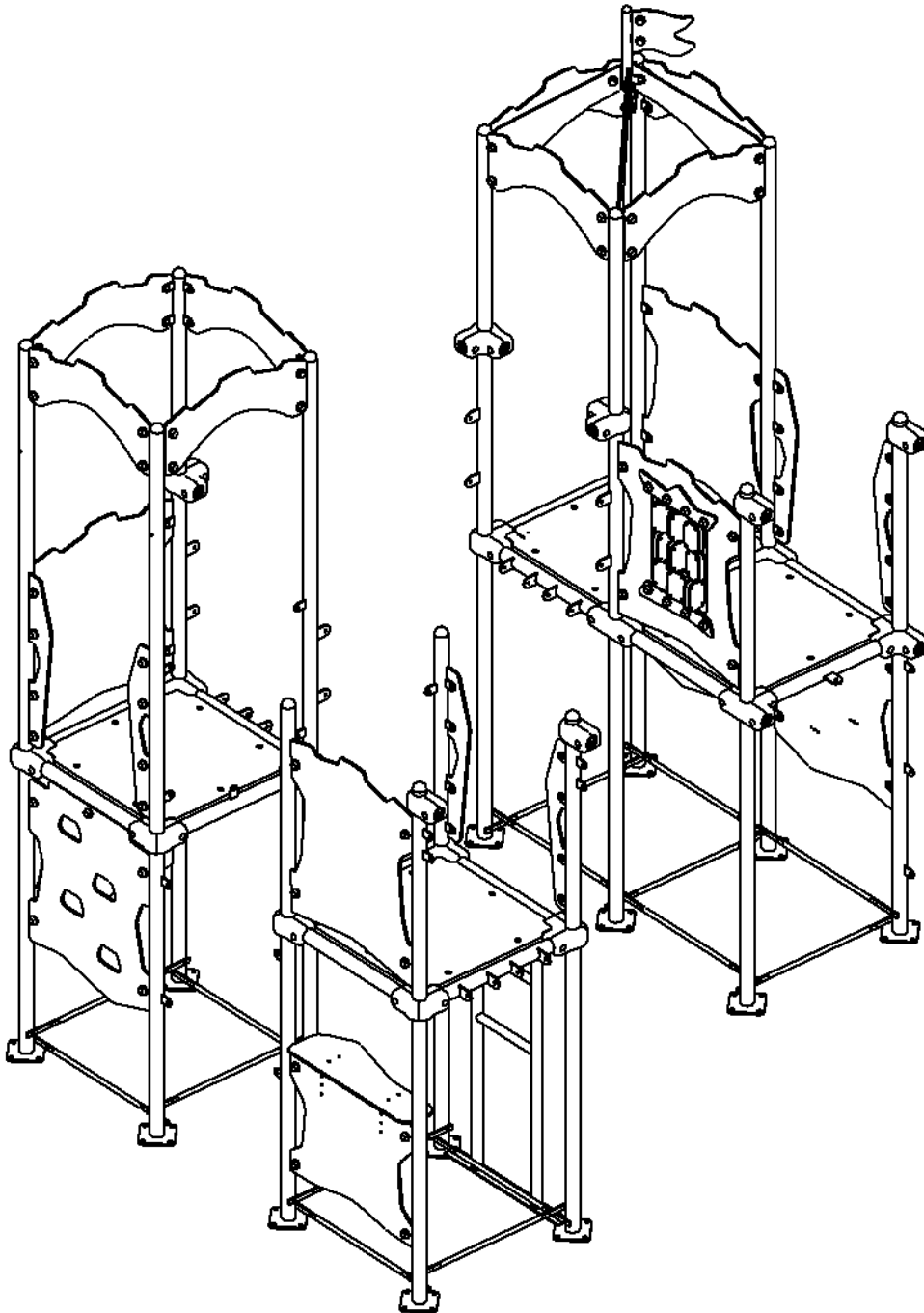

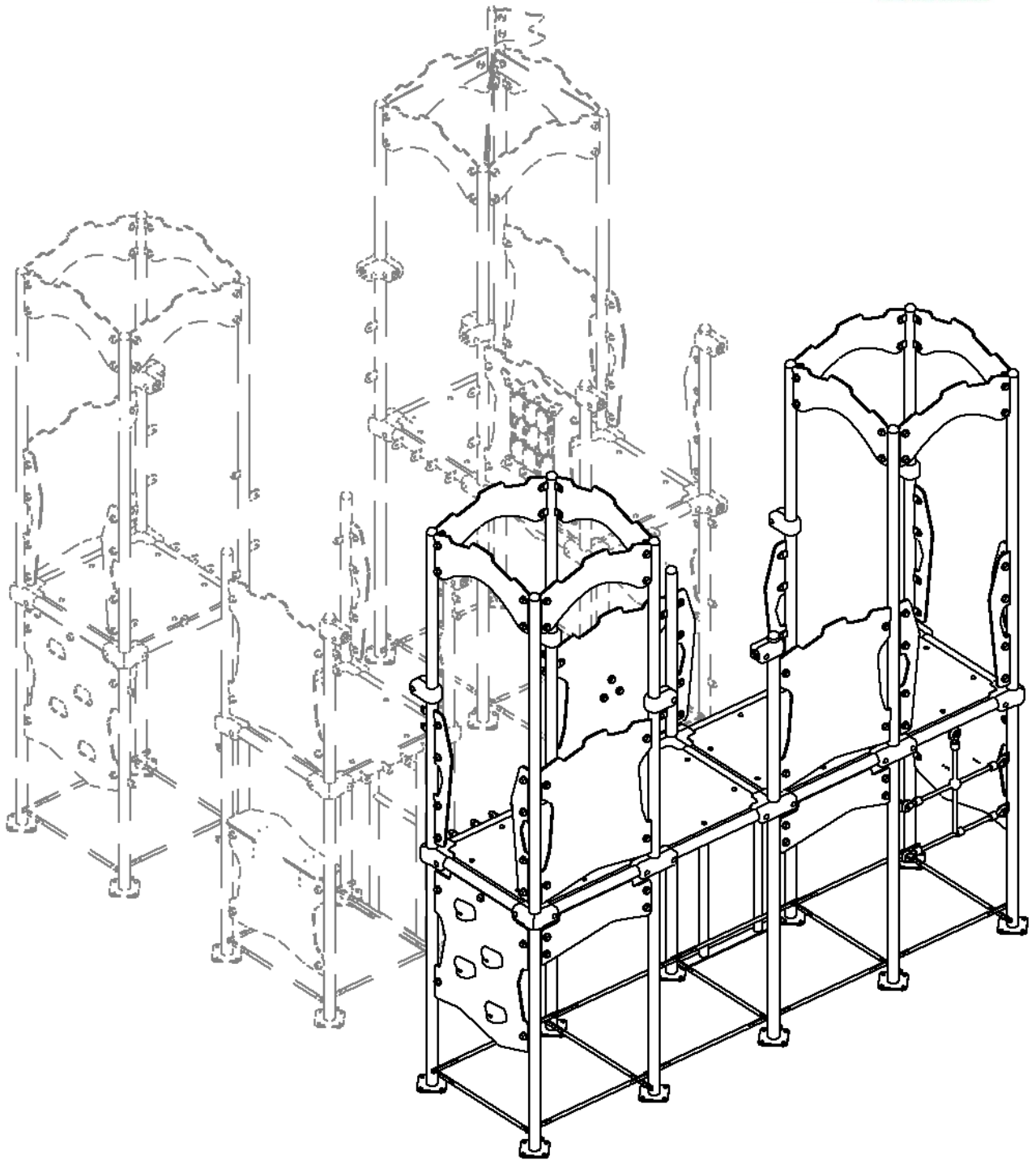

5. Podzespoły Components

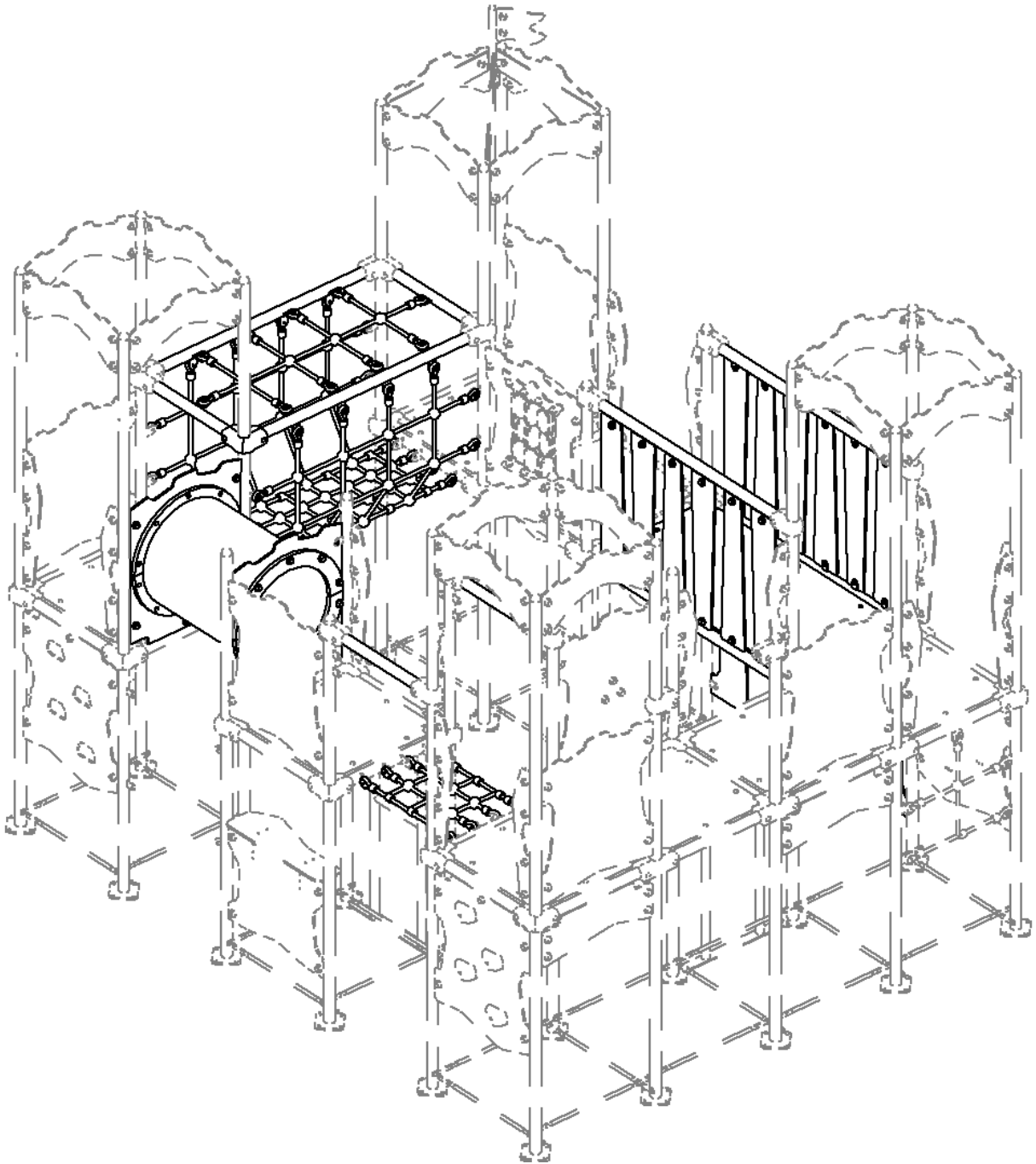

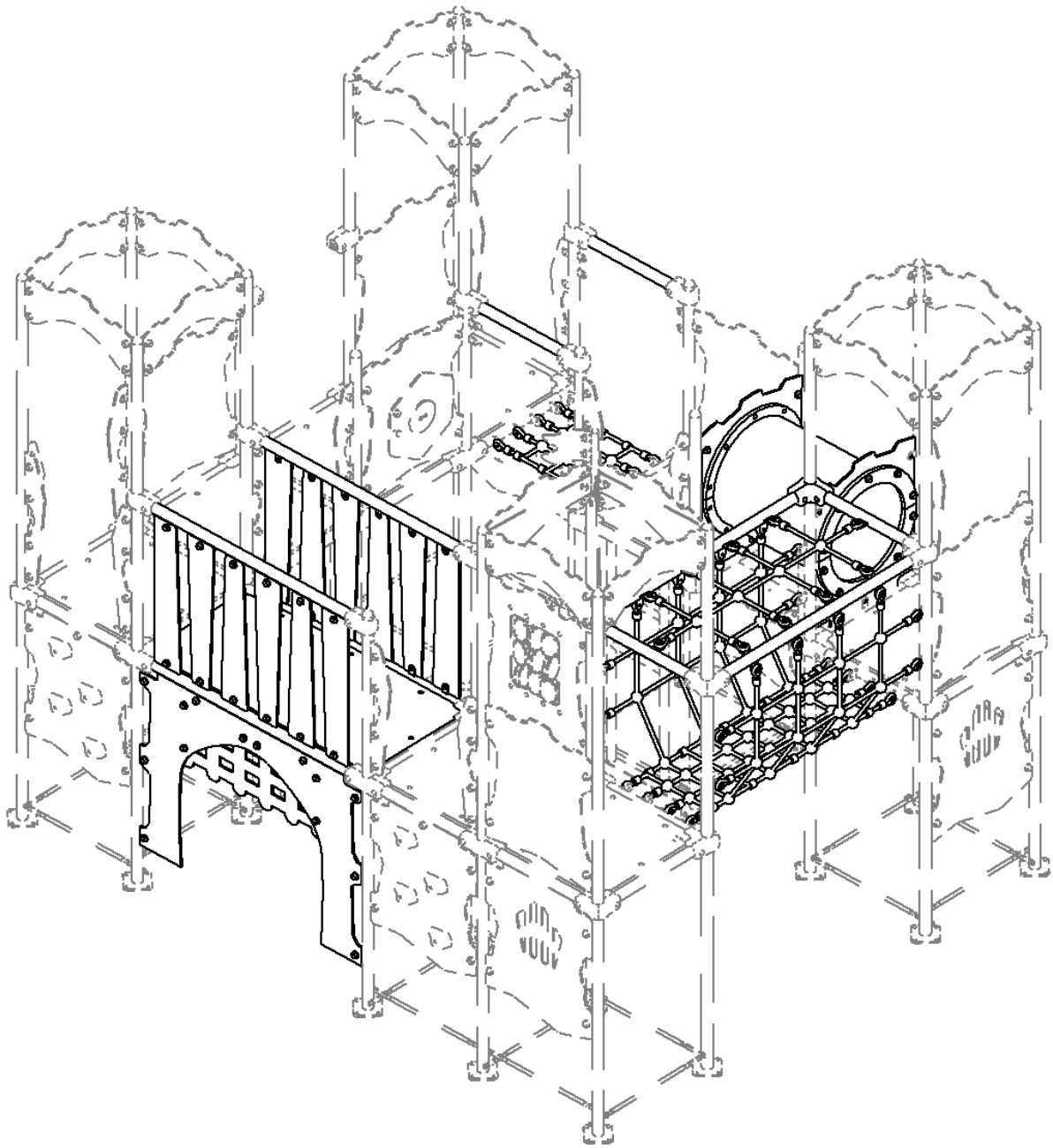

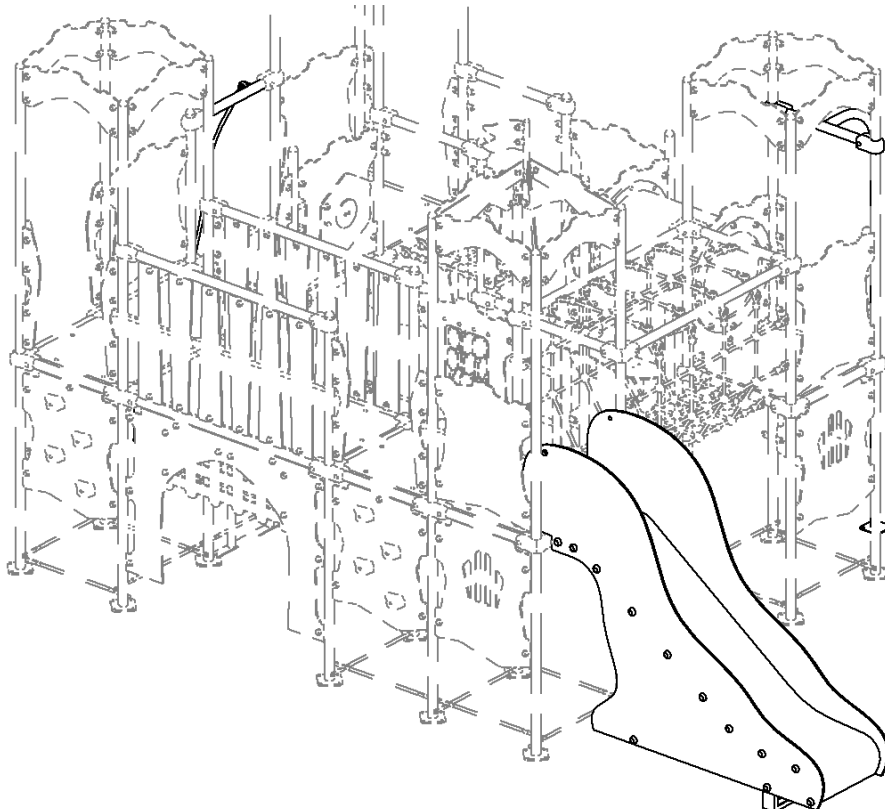
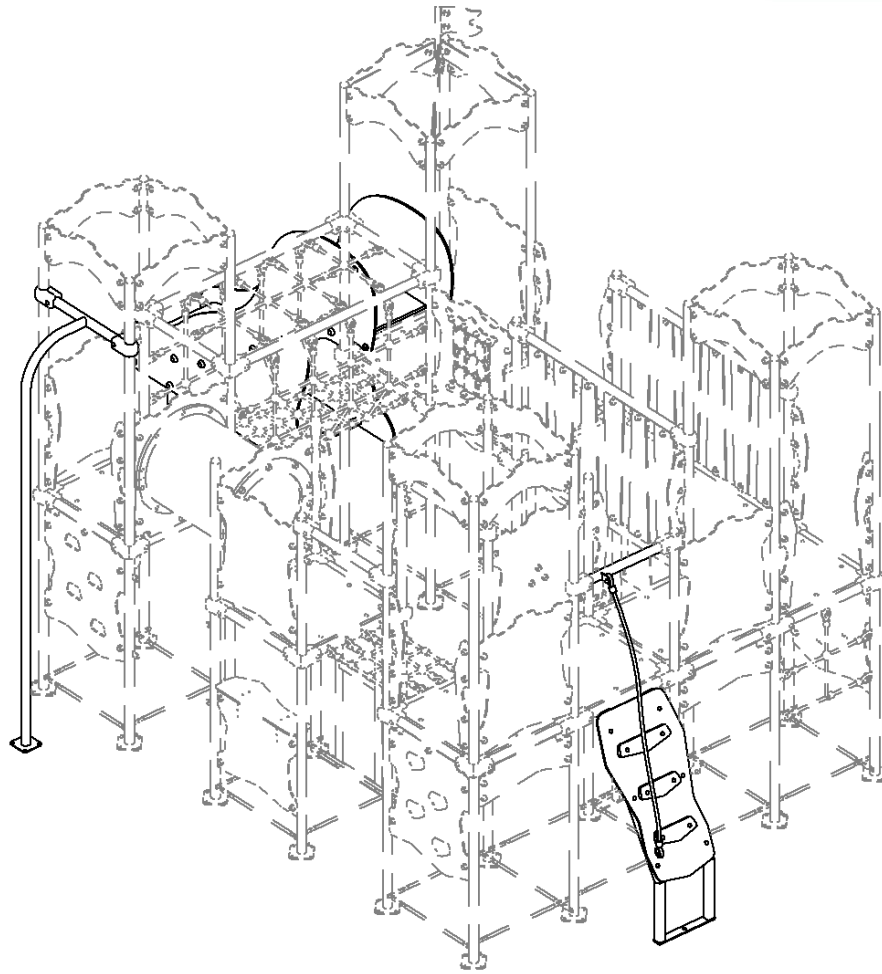

Zjeżdżalnia / slide

