

INSTRUKCJA MONTAŻU

INSTALLATION INSTRUCTION

Wydanie <i>Edition</i>	01
Data <i>Date</i>	2024-09-30

ZESTAW AVENIR

AVENIR SET

Numer katalogowy
catalogue number **72503**













1. Informacje techniczne

Technical information

Grupa wiekowa <i>User age</i>	do 14 lat
Maksymalna wysokość swobodnego upadku <i>Max. free fall height</i>	0,71 m
Największa część <i>Largest part</i>	Zjeżdżalnia <i>Slide</i>
Wymiary największej części <i>Largest part dimensions</i>	1,3 x 0,8 x 0,6 m
Masa największej części <i>Largest part weight</i>	35 kg
Masa największego fundamentu <i>Largest foundation weight</i>	60 kg
Zgodność z normami <i>Accordance with standards</i>	EN 1176-1 EN 1176-3

2. Wykaz narzędzi

Tools list

3. Fundamenty i powierzchnia zderzenia

Foundations and impact area



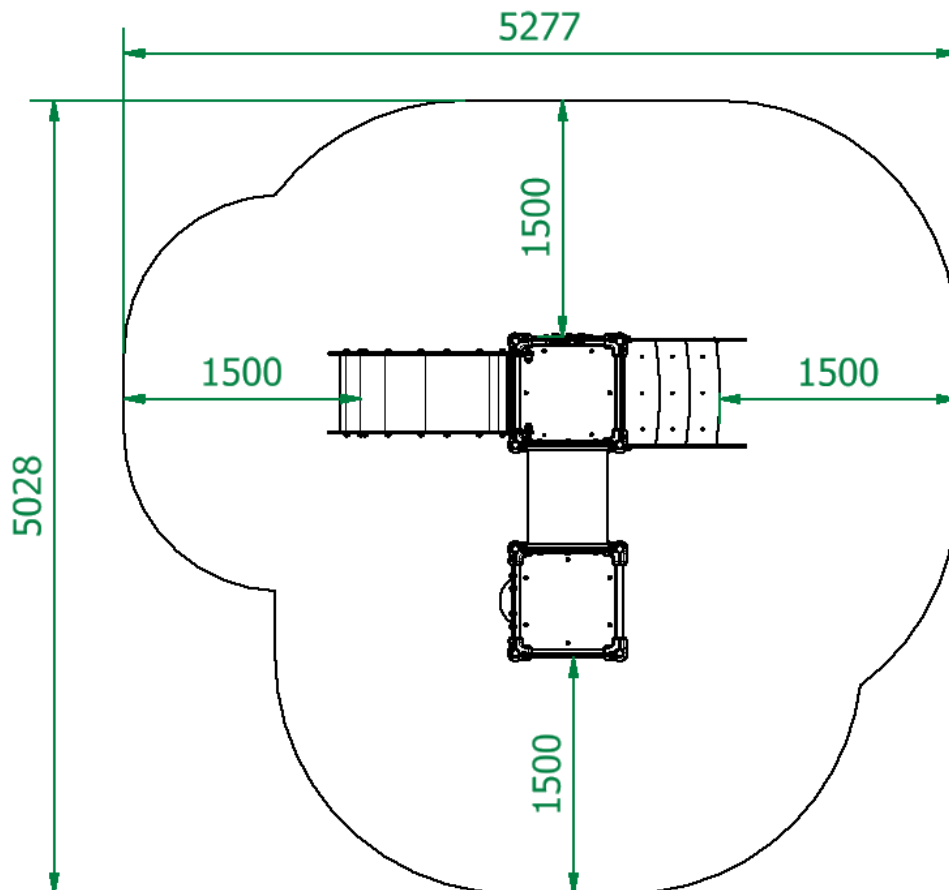

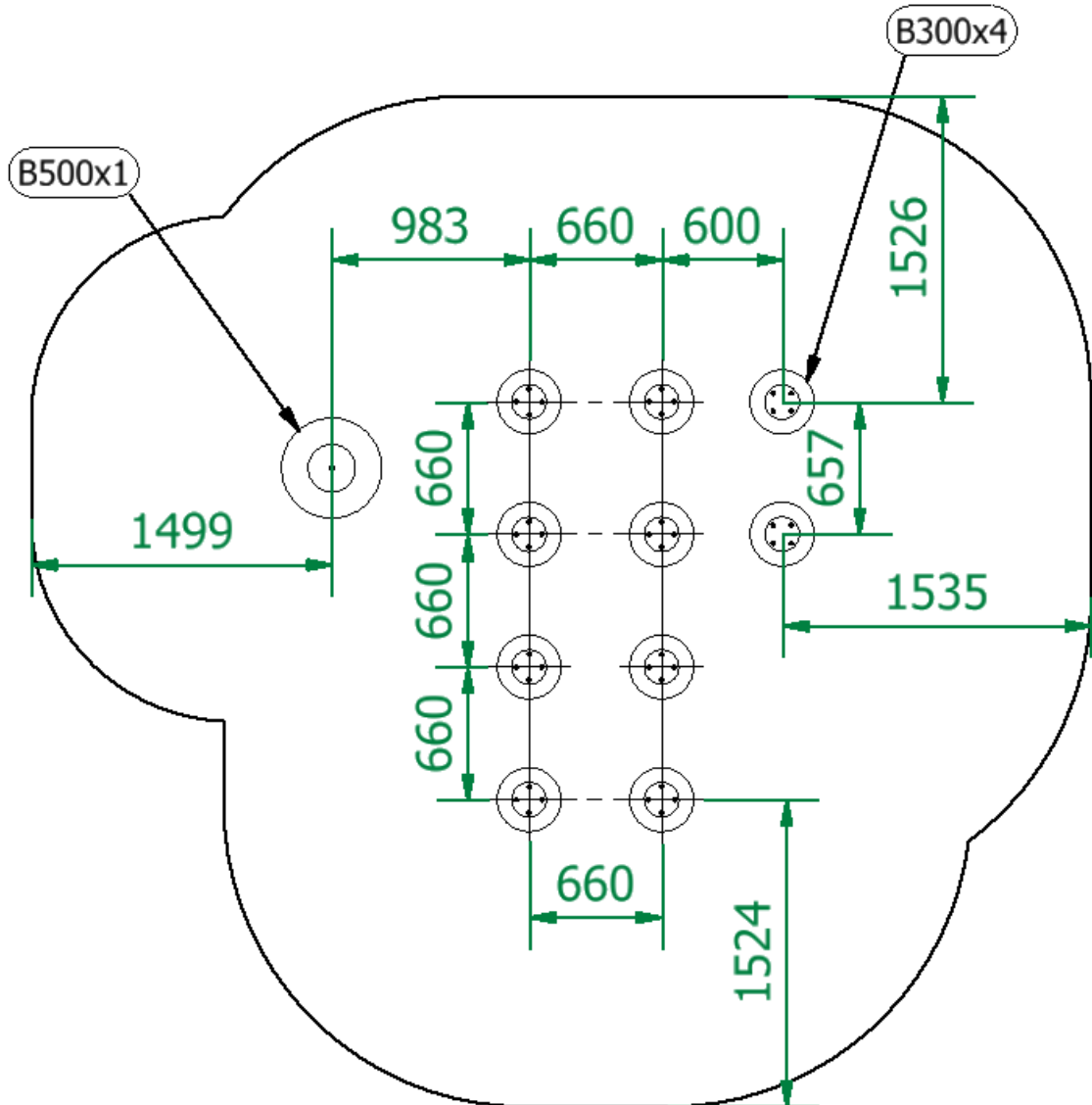
NUMER/NUMBER	SZT./PCS
B500x1	1
B300x4	10

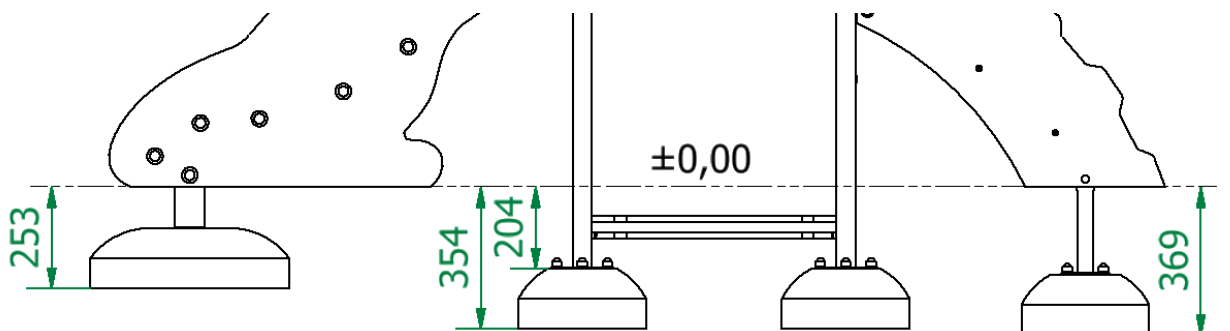

4. Wieże Towers

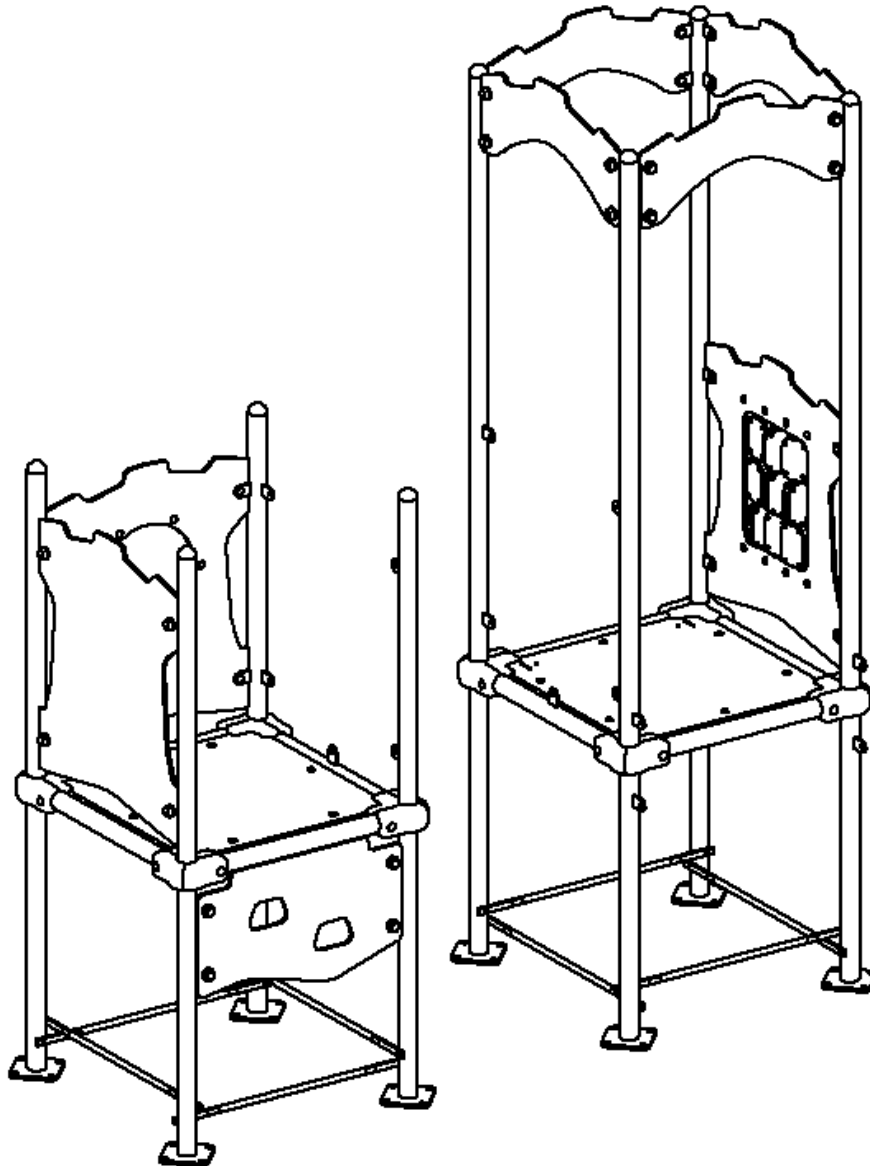

5. Podzespoły Components

