

STANDARD MINI PLAYGROUND SET NO. 05

Catalogue number: 71005

Users' age group:	up to 14 years
Max. free fall height:	0,48 m
Product Dimensions: (length x width x height)	4,13 x 0,70 x 1,87 m
Impact area: (length x width)	7,62 x 3,90 m



Technical description

- A solid construction made of hot dip galvanized, painted steel (71005)
- Side surfaces made of HDPE and HPL sheets
- The decks made of an anti-slip waterproof plywood, 21mm thick
- All steel elements are protected against corrosion
- Includes a foundation made of concrete class C25/30 which make installation easier

Product dimensions

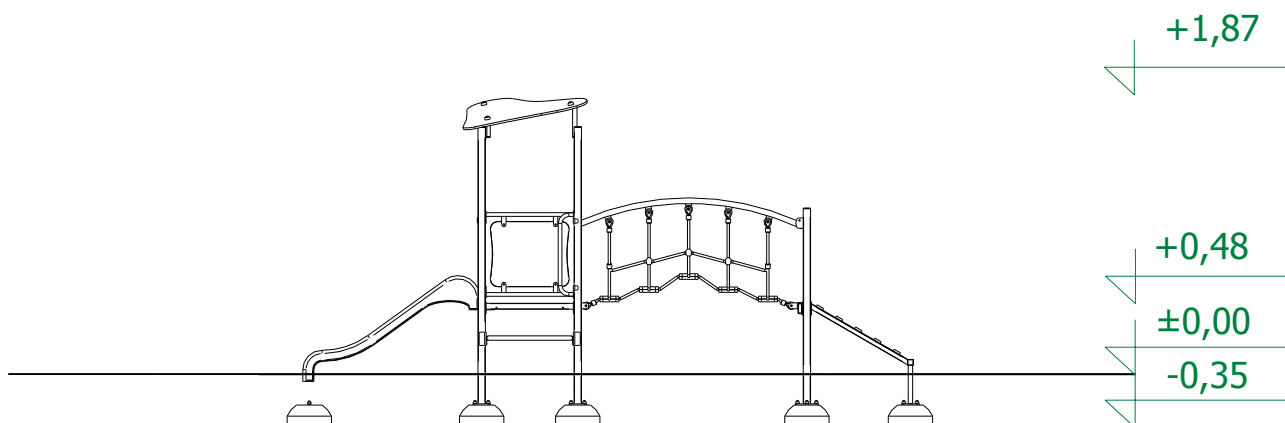

TECHNICAL DATA SHEET

Impact area dimensions

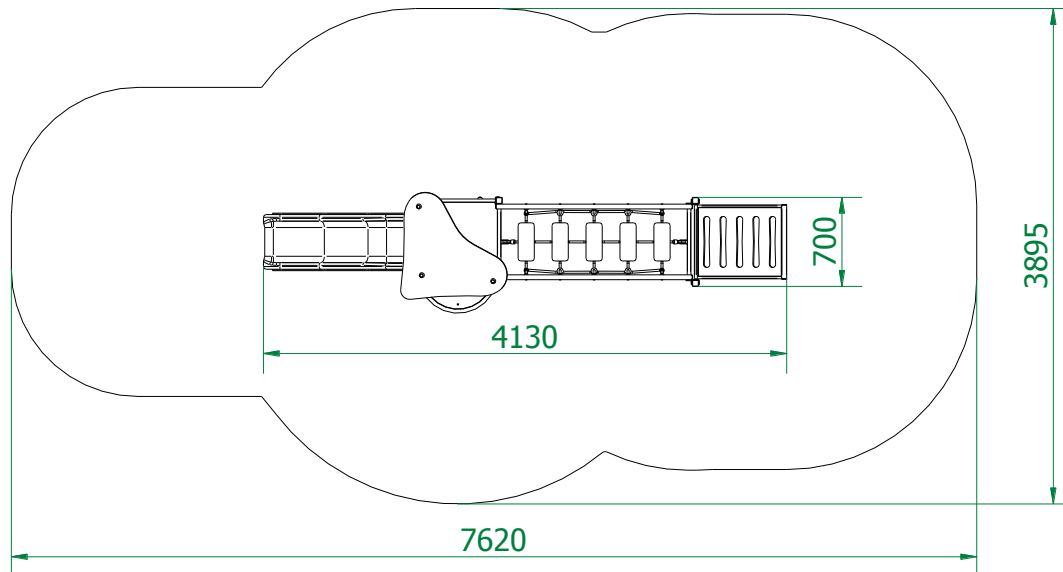

Permissible impact attenuating surface:

- Bark – grain size 20 do 80 mm, min. depth 200mm
- Woodchip – grain size 5 do 30 mm, min. depth 200mm
- Sand – grain size 0,2 do 2 mm, min. depth 200mm
- Gravel – grain size 2 do 8 mm, min. depth 200mm
- Synthetic surfaces in accordance whit tested HIC (EN 1177)

*The impact attenuating surfacing shall be installed on the whole of impact area.
A loose-fill safety surface shall be 100mm thicker than min. depth indicated above.*

