

## STANDARD MINI PLAYGROUND SET NO. 06

Catalogue number: 71006

<b>Users' age group:</b>	up to 14 years
<b>Max. free fall height:</b>	0,48 m
<b>Product Dimensions:</b> (length x width x height)	3,61 x 2,82 x 1,87 m
<b>Impact area:</b> (length x width)	6,61 x 5,99 m



### Technical description

- A solid construction made of hot dip galvanized, painted steel (71006)
- Side surfaces made of HDPE and HPL sheets
- The decks made of an anti-slip waterproof plywood, 21mm thick
- All steel elements are protected against corrosion
- Includes a foundation made of concrete class C25/30 which make installation easier

### Product dimensions

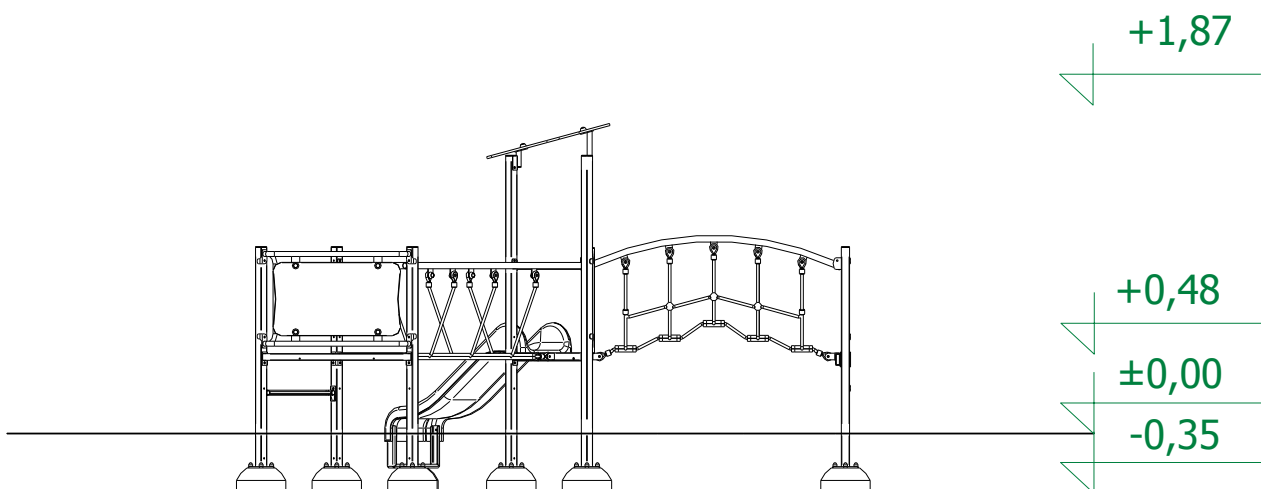

## TECHNICAL DATA SHEET

### Impact area dimensions

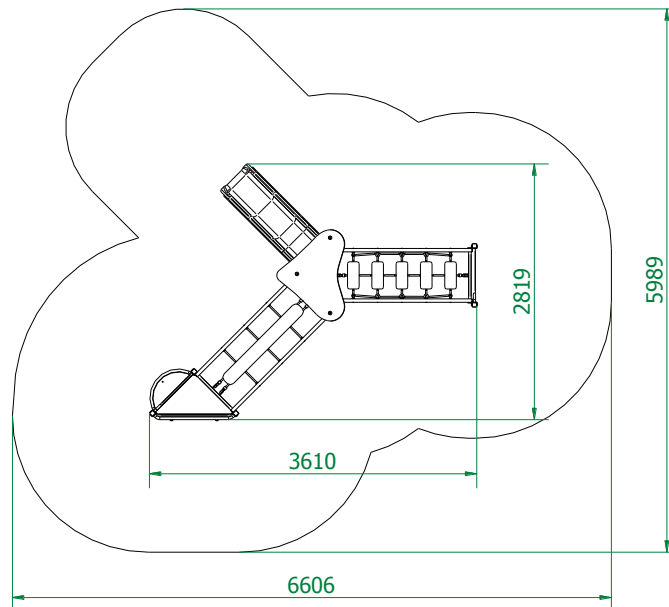

### Permissible impact attenuating surface:

- Bark – grain size 20 do 80 mm, min. depth 200mm
- Woodchip – grain size 5 do 30 mm, min. depth 200mm
- Sand – grain size 0,2 do 2 mm, min. depth 200mm
- Gravel – grain size 2 do 8 mm, min. depth 200mm
- Synthetic surfaces in accordance whit tested HIC (EN 1177)

*The impact attenuating surfacing shall be installed on the whole of impact area.  
A loose-fill safety surface shall be 100mm thicker than min. depth indicated above.*

