

# HUŚTAWKA POJEDYNCZA FUTURA

Numer katalogowy  
Catalogue number

**77101, 77101-A**

## INSTRUKCJA MONTAŻU INSTALLATION INSTRUCTION

Wydanie Edition	03
Data Date	30-11-2015

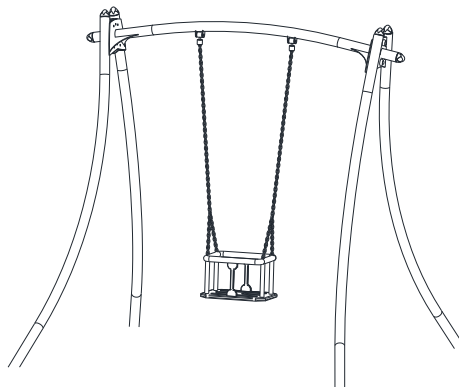
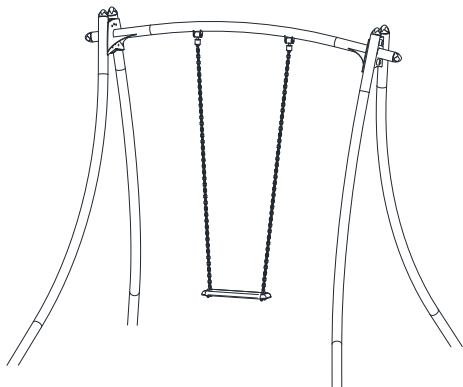

### 1. Informacje techniczne Technical information

Grupa wiekowa User age	3 - 14
Maksymalna wysokość swobodnego upadku Max. free fall height	1,20 m
Wymiary największej części Largest part dimensions	178x723x2612 mm
Masa największej części Largest part weight	
Zgodność z normami Accordance with standards	EN 1176-1:2008 EN 1176-2:2008





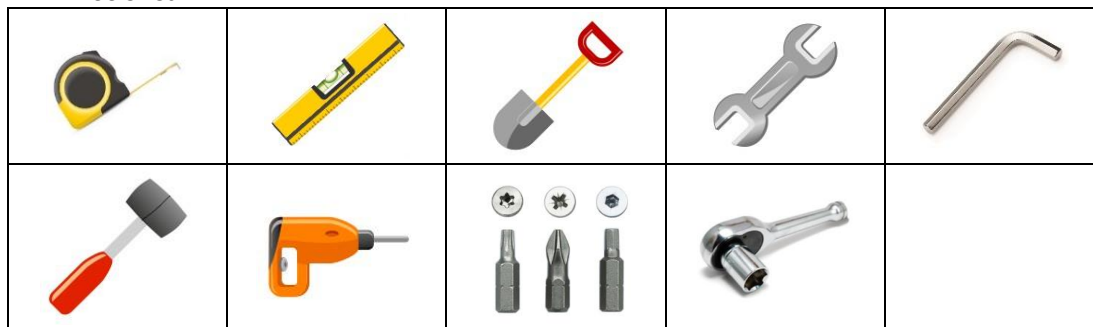





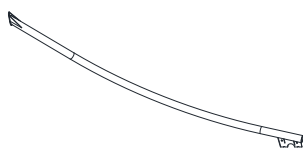
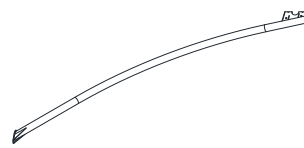
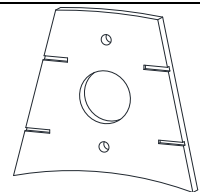

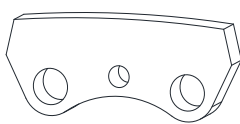
## 2. Wykaz narzędzi

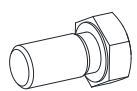
### Tools list

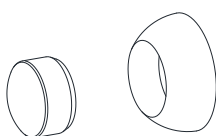
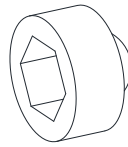

## 3. Wykaz części

### Parts list

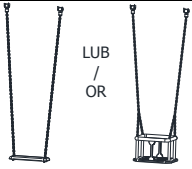
															
Nr No.	<b>1</b>	Szt. Pcs	1	Nr No.	<b>2</b>	Szt. Pcs	2	Nr No.	<b>3</b>	Szt. Pcs	2	Nr No.	<b>4</b>	Szt. Pcs	2
								M10x70 				M10x20 			
Nr No.	<b>5</b>	Szt. Pcs	2	Nr No.	<b>6</b>	Szt. Pcs	2	Nr No.	<b>7</b>	Szt. Pcs	4	Nr No.	<b>8</b>	Szt. Pcs	8
M16x30 				20x10,5 				18,1x10,7 				30x17 			
Nr No.	<b>9</b>	Szt. Pcs	4	Nr No.	<b>10</b>	Szt. Pcs	24	Nr No.	<b>11</b>	Szt. Pcs	4	Nr No.	<b>12</b>	Szt. Pcs	4
M10 				M10 											
Nr No.	<b>13</b>	Szt. Pcs	4	Nr No.	<b>14</b>	Szt. Pcs	8	Nr No.	<b>15</b>	Szt. Pcs	8	Nr No.	<b>16</b>	Szt. Pcs	4
				 LUB / OR											
Nr No.	<b>17</b>	Szt. Pcs	6	Nr No.	<b>18</b>	Szt. Pcs	1								

#### 4. Etapy instalacji Installation steps

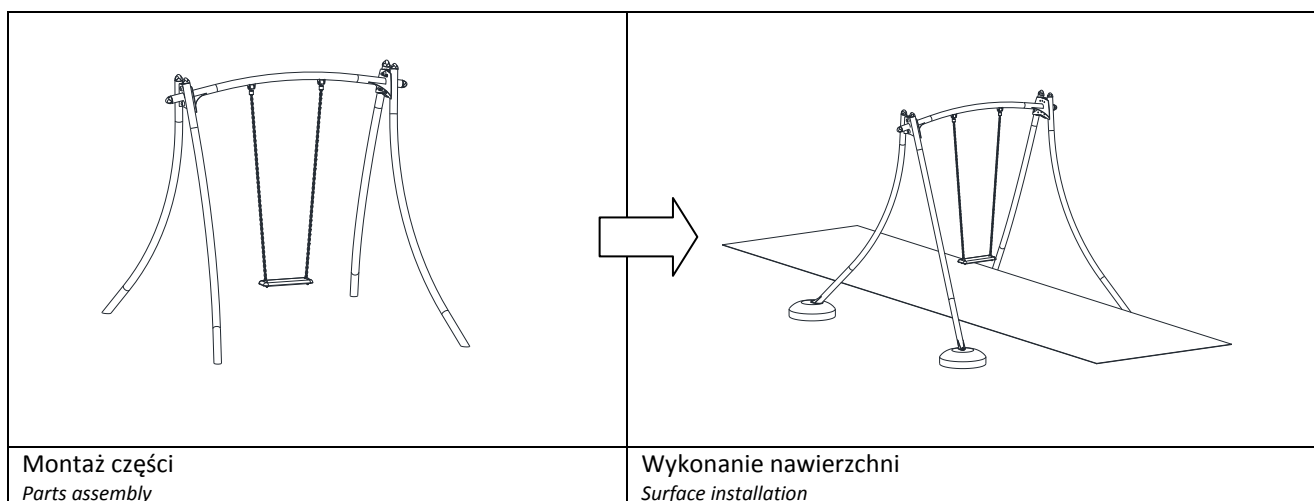
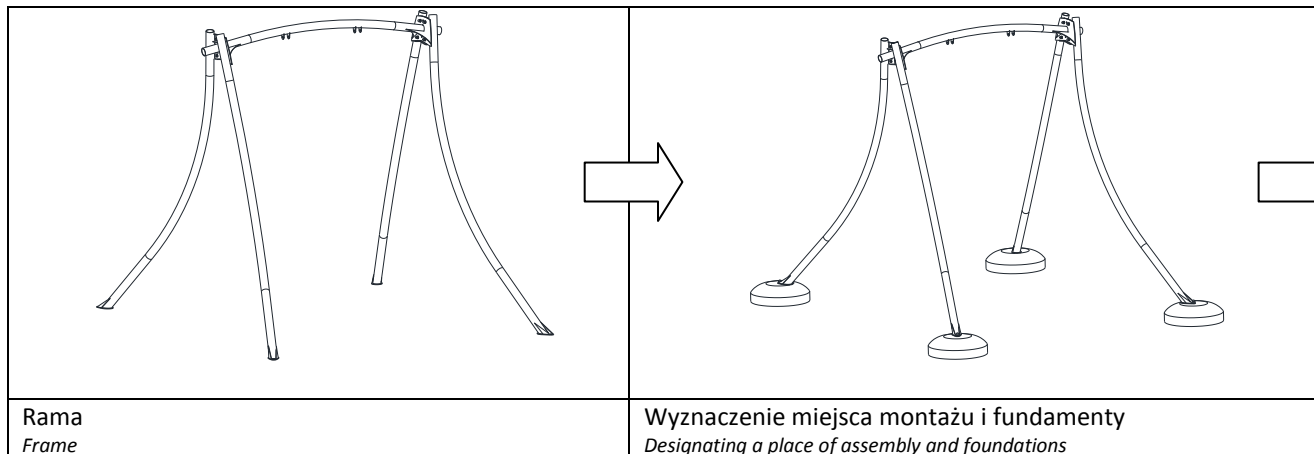

5. Rama  
Frame

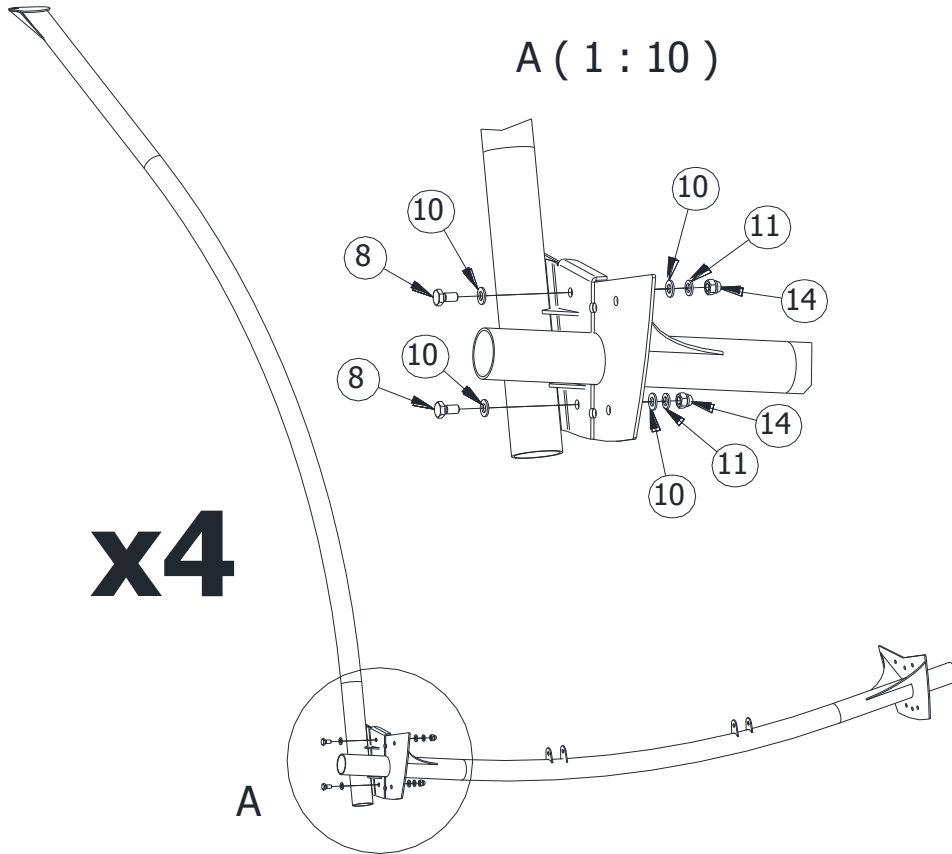

## 6. Wyznaczenie miejsca montażu i fundamenty

*Designating a place of assembly and foundations*

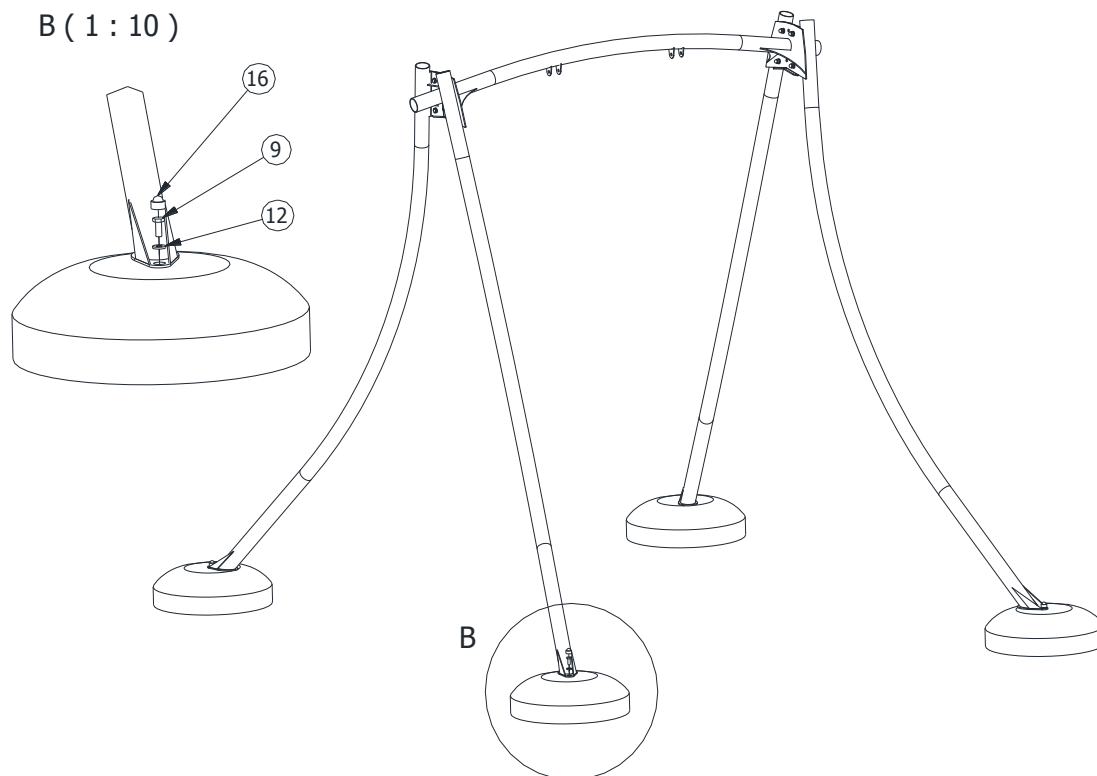
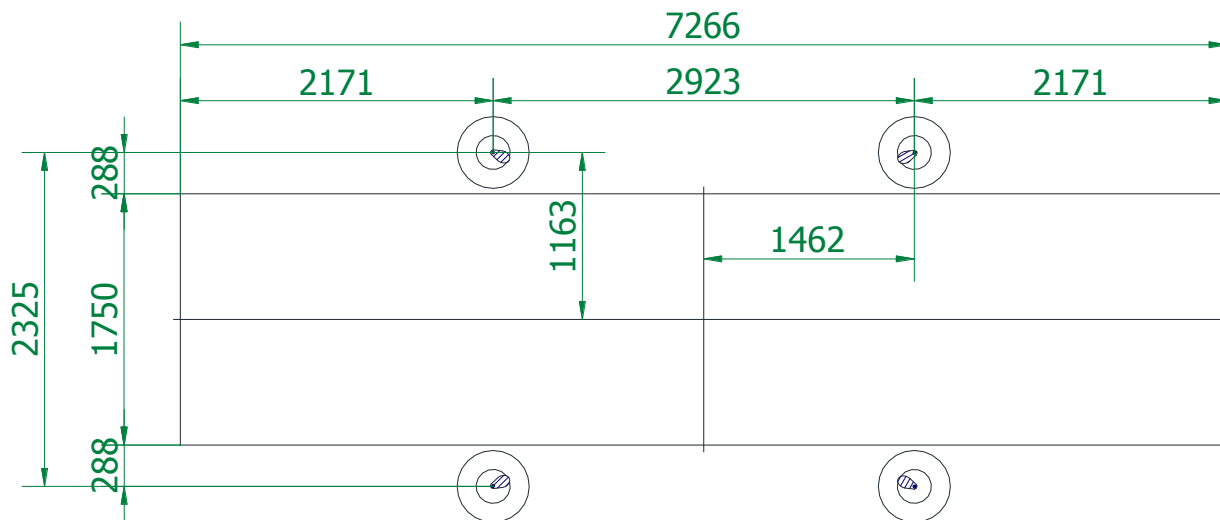

## 7. Montaż części

Parts assembly

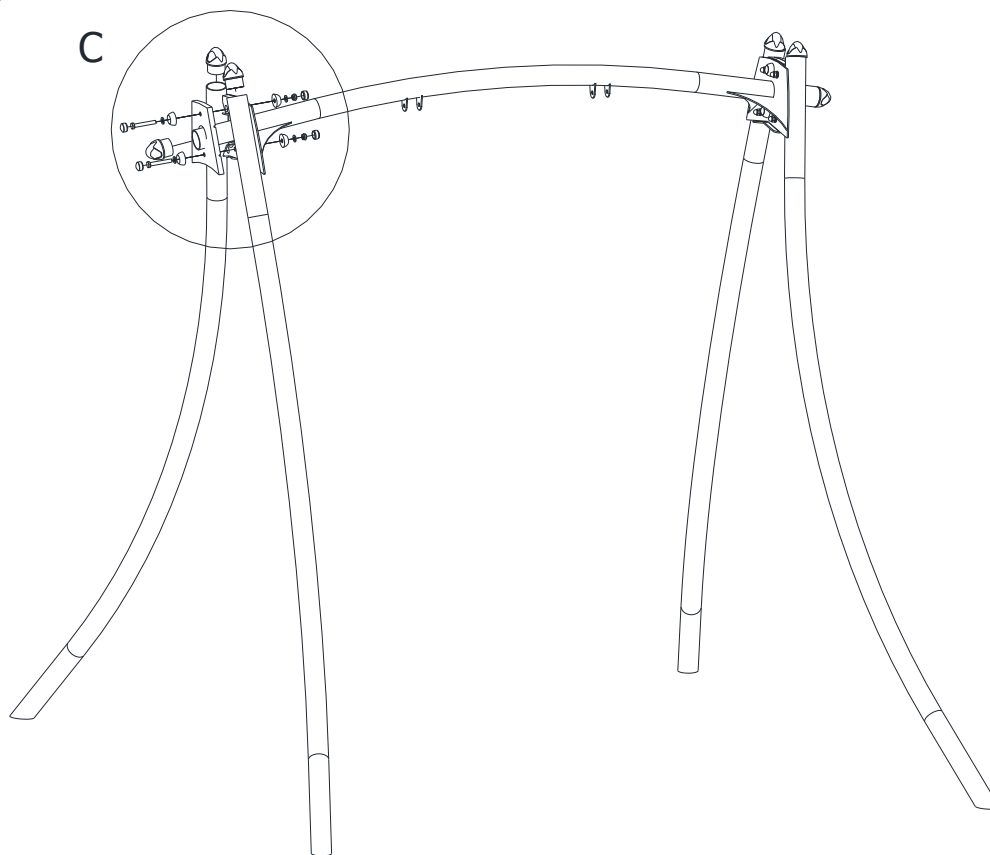

C ( 1 : 10 )

