

# HUŚTAWKA PODWÓJNA FUTURA

## INSTRUKCJA MONTAŻU INSTALLATION INSTRUCTION

Numer katalogowy  
Catalogue number

**77103, 77103-A, 77103-  
B**

Wydanie  
Edition

03

Data  
Date

15-05-2023

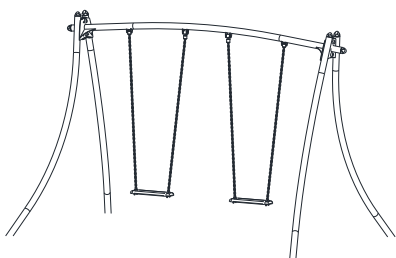

**77103**

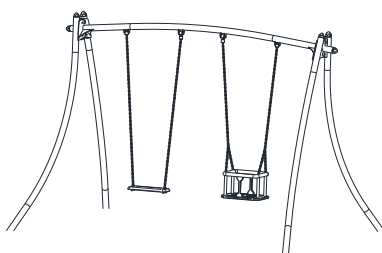

**77103-A**

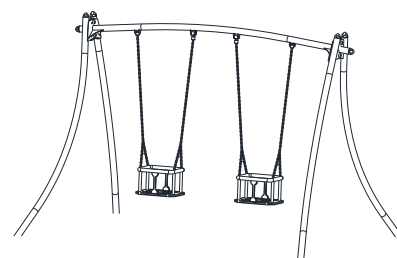

**77103-B**

### 1. Informacje techniczne Technical information

<b>Grupa wiekowa</b> <i>User age</i>	3 - 14
<b>Maksymalna wysokość swobodnego upadku</b> <i>Max. free fall height</i>	1,20 m
<b>Wymiary największej części</b> <i>Largest part dimensions</i>	178x723x2612 mm
<b>Zgodność z normami</b> <i>Accordance with standards</i>	EN 1176-1:2008 EN 1176-2:2008





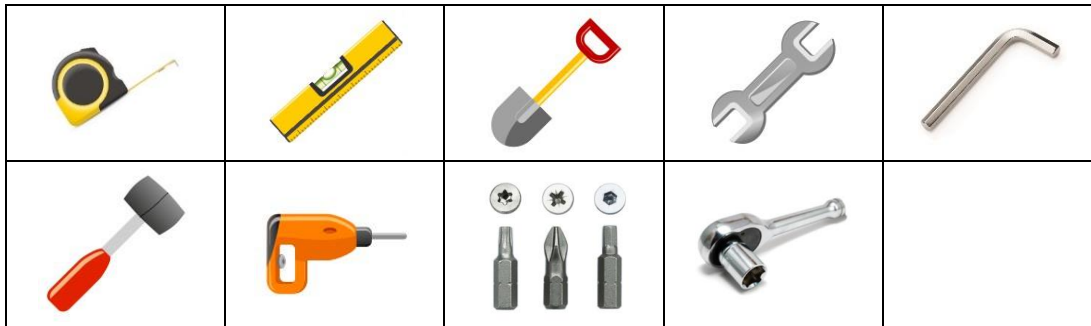



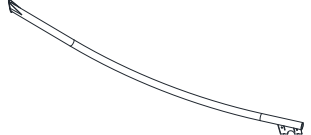
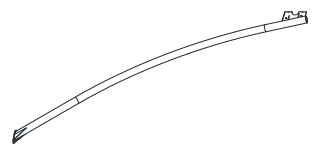
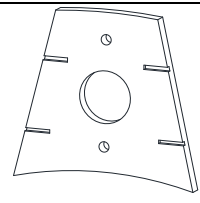

## 2. Wykaz narzędzi

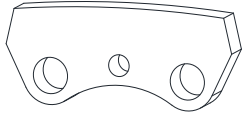
### Tools list

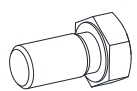

## 3. Wykaz części

### Parts list

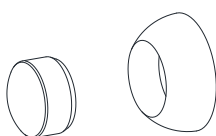
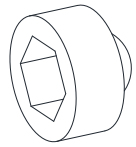
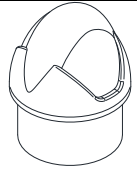
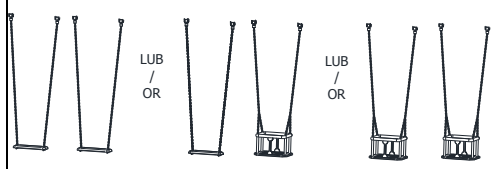
															
Nr No.	<b>1</b>	Szt. Pcs	1	Nr No.	<b>2</b>	Szt. Pcs	2	Nr No.	<b>3</b>	Szt. Pcs	2	Nr No.	<b>4</b>	Szt. Pcs	2
								M10x70 				M10x20 			
Nr No.	<b>5</b>	Szt. Pcs	2	Nr No.	<b>6</b>	Szt. Pcs	2	Nr No.	<b>7</b>	Szt. Pcs	4	Nr No.	<b>8</b>	Szt. Pcs	8
M16x30 				20x10,5 				18,1x10,7 				30x17 			
Nr No.	<b>9</b>	Szt. Pcs	4	Nr No.	<b>10</b>	Szt. Pcs	24	Nr No.	<b>11</b>	Szt. Pcs	4	Nr No.	<b>12</b>	Szt. Pcs	4
M10 				M10 											
Nr No.	<b>13</b>	Szt. Pcs	4	Nr No.	<b>14</b>	Szt. Pcs	8	Nr No.	<b>15</b>	Szt. Pcs	8	Nr No.	<b>16</b>	Szt. Pcs	4
				 <p>LUB / OR</p>											
Nr No.	<b>17</b>	Szt. Pcs	6	Nr No.	<b>18</b>	Szt. Pcs	1								

#### 4. Etapy instalacji Installation steps

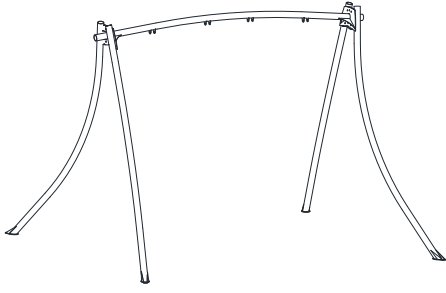
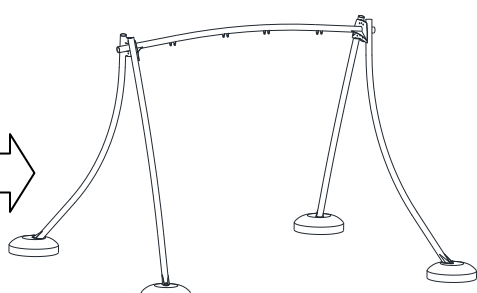
	
<p>Rama Frame</p>	<p>Wyznaczenie miejsca montażu i fundamenty Designating a place of assembly and foundations</p>

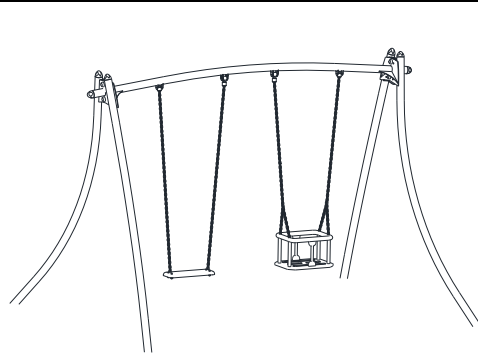
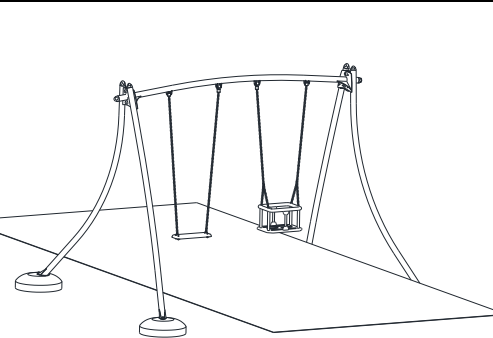
	
<p>Montaż części Parts assembly</p>	<p>Wykonanie nawierzchni Surface installation</p>

5. Rama  
Frame

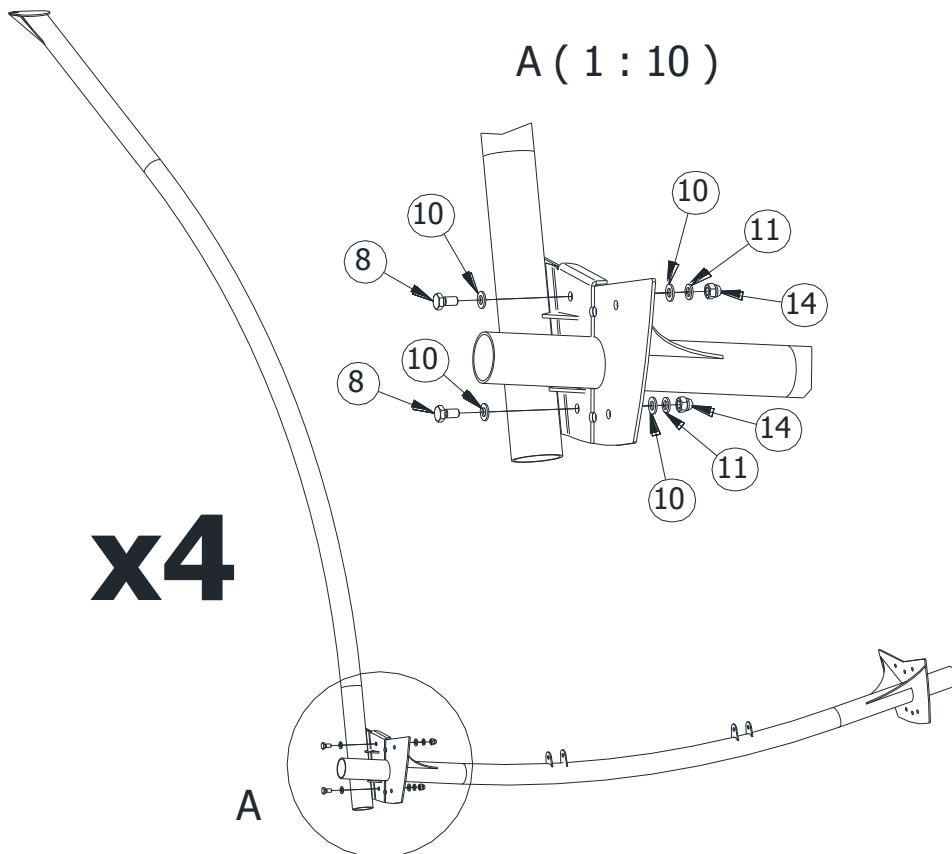

## 6. Wyznaczenie miejsca montażu i fundamenty

*Designating a place of assembly and foundations*

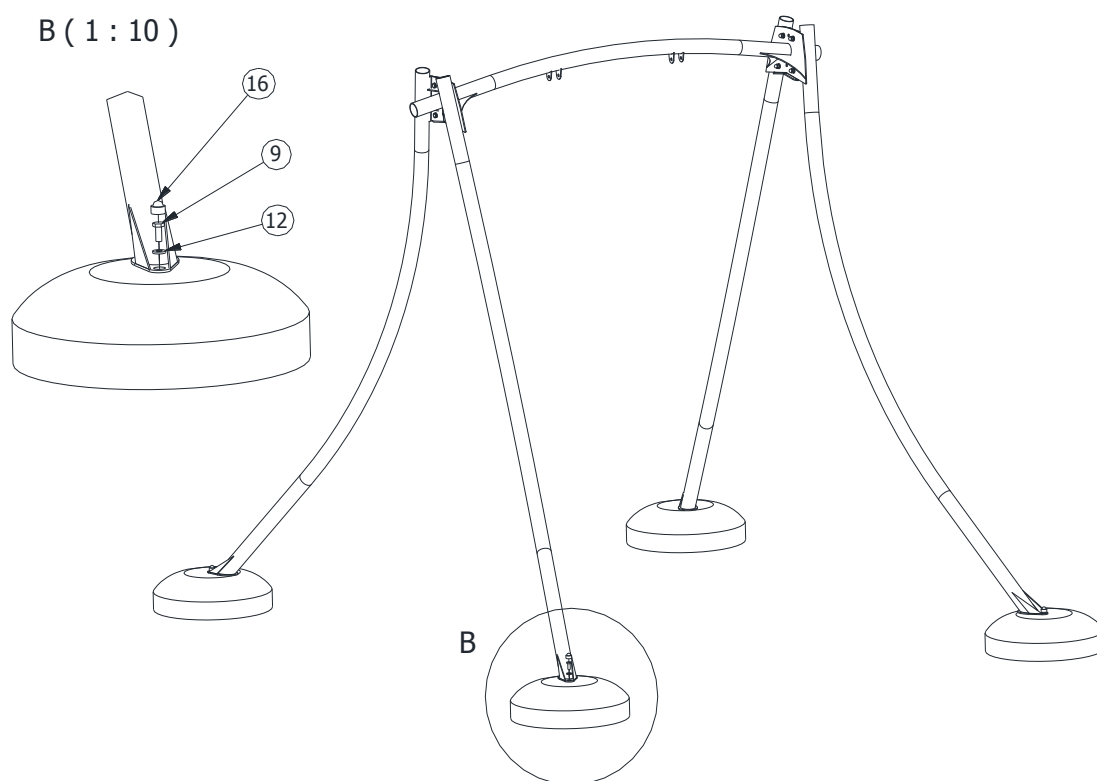
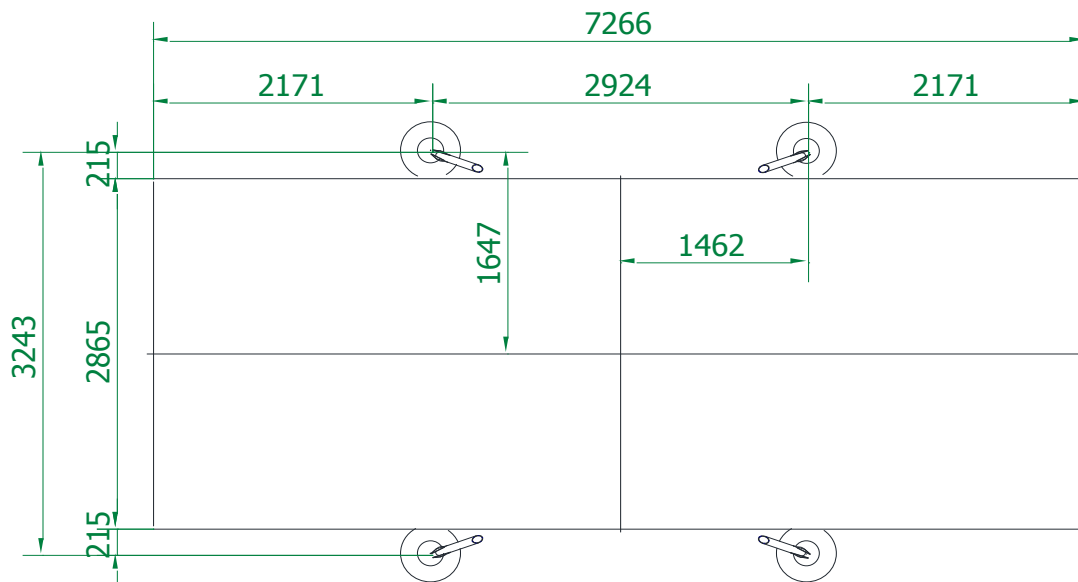

## 7. Montaż części

Parts assembly

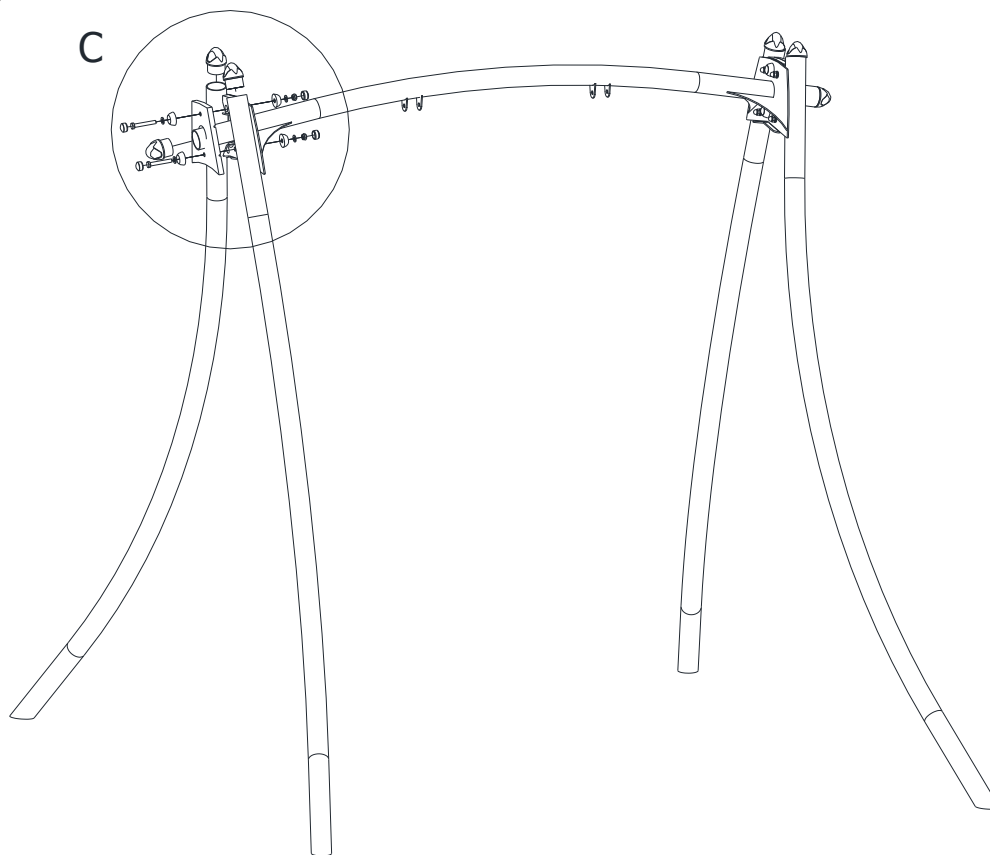

C ( 1 : 10 )

