

## FUTURA SET NO. 5

Catalogue number: 77705

<b>Users' age group:</b>	up to 14 years
<b>Max. free fall height:</b>	1,94 m
<b>Product Dimensions:</b> (length x width x height)	4,95 x 2,61 x 2,72 m
<b>Impact area:</b> (length x width)	7,95 x 5,52 m



### Technical description

- Stainless steel construction
- Non-slip, waterproof plywood platforms
- Stainless steel & HDPE slide
- HPL side panels and climbing walls
- HDPE construction components
- The set includes foundations made of concrete class C25/30
- Standard side panels can be replaced with play/educational panels from our offer

### Product dimensions

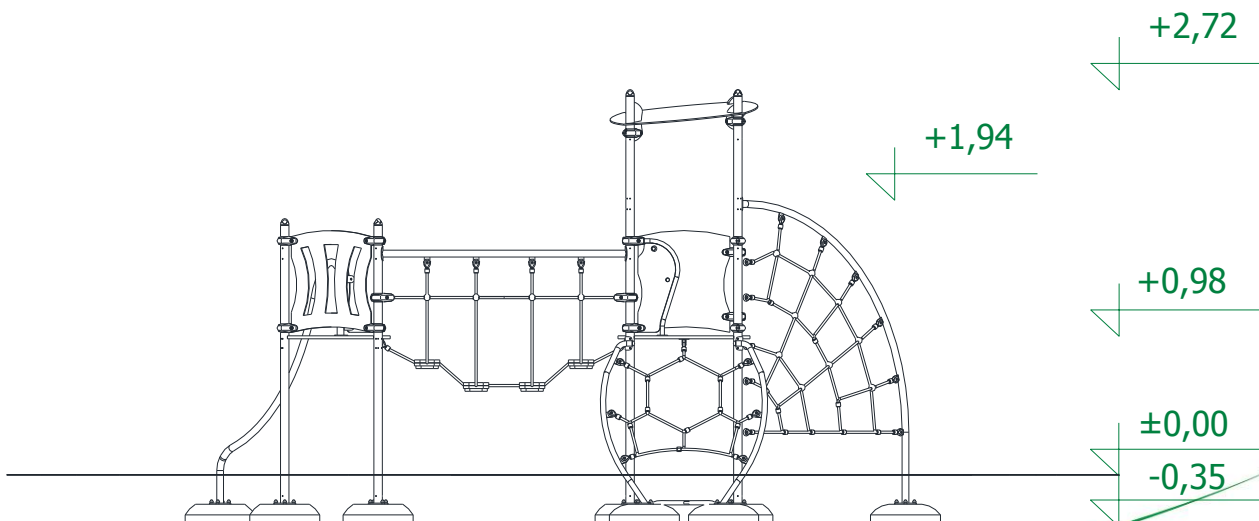

## TECHNICAL DATA SHEET

### Impact area dimensions

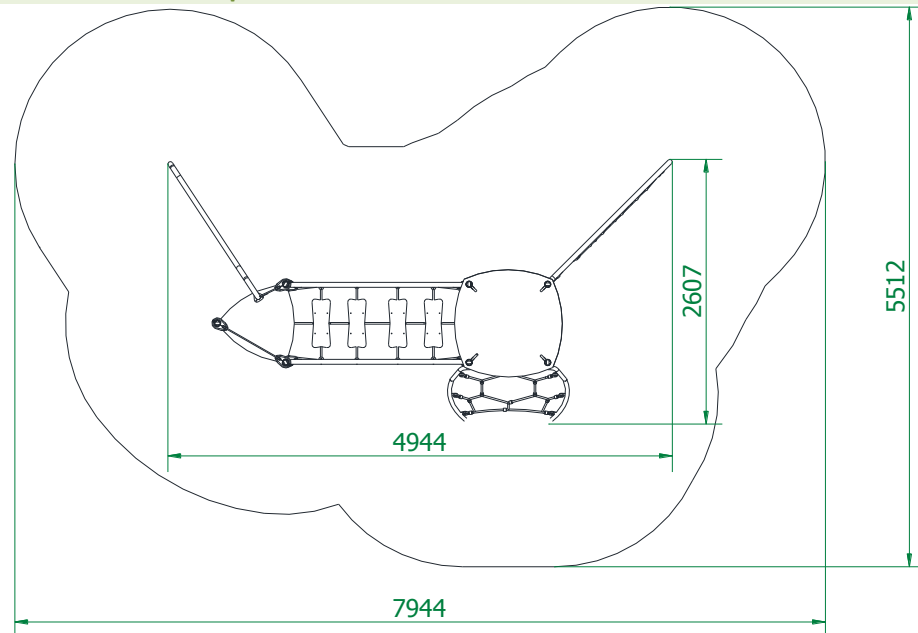

### Permissible impact attenuating surface

- Bark – grain size 20 do 80 mm, min. depth 200 mm + 100mm (for displacement)
- Woodchip – grain size 5 do 30 mm, min. depth 200mm + 100mm (for displacement)
- Sand – grain size 0,2 do 2 mm, min. depth 200mm + 100mm (for displacement)
- Gravel – grain size 2 do 8 mm, min. depth 200 mm+ 100mm (for displacement)
- Synthetic surfaces in accordance whit tested HIC (EN 1177)

*The impact attenuating surfacing shall be installed on the whole of impact area.*

