

FUTURA PLAY SET NO. 50

Catalogue number: 77750

Users' age group:	up to 14 years
Max. free fall height:	0,63 m
Product Dimensions: (length x width x height)	1,84 x 0,88 x 1,46 m
Impact area: (length x width)	4,26 x 3,77 m



Technical description

- Stainless steel construction
- Non-slip, waterproof plywood platforms
- Stainless steel & HDPE slide
- HPL side panels and climbing walls
- HDPE construction components
- The set includes foundations made of concrete class C25/30
- Standard side panels can be replaced with play/educational panels from our offer

Product dimensions

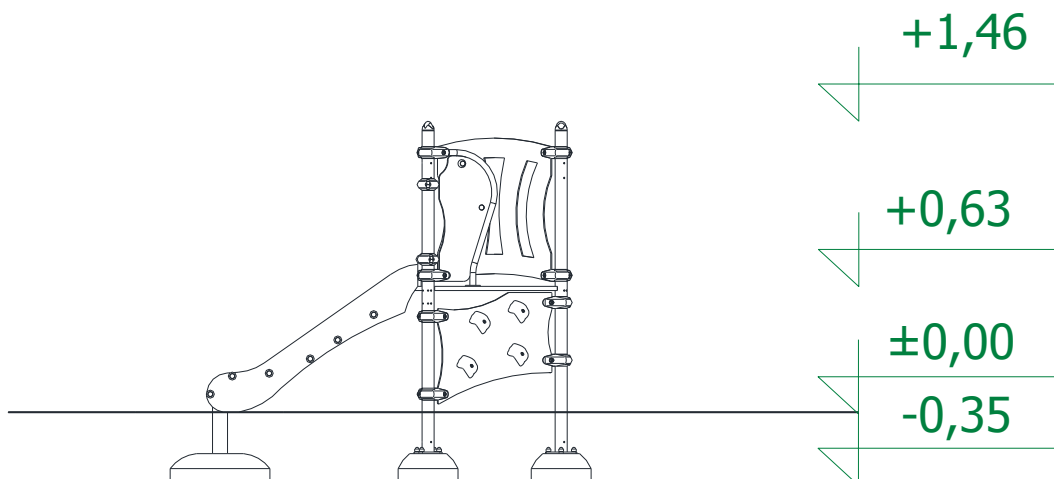

TECHNICAL DATA SHEET

Impact area dimensions

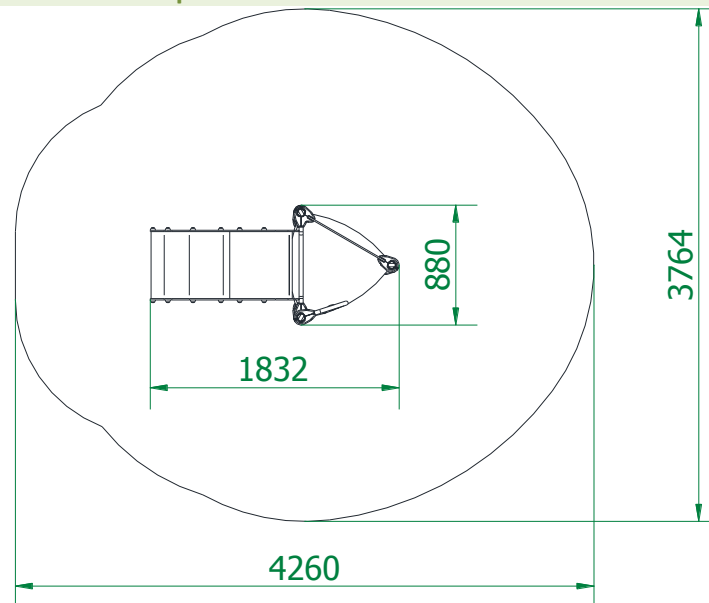

Permissible impact attenuating surface

- Turf, topsoil
- Bark – grain size 20 do 80 mm, min. depth 200 mm + 100mm (for displacement)
- Woodchip – grain size 5 do 30 mm, min. depth 200mm + 100mm (for displacement)
- Sand – grain size 0,2 do 2 mm, min. depth 200mm + 100mm (for displacement)
- Gravel – grain size 2 do 8 mm, min. depth 200 mm+ 100mm (for displacement)
- Synthetic surfaces in accordance whit tested HIC (EN 1177)

The impact attenuating surfacing shall be installed on the whole of impact area.

