

PLAYSET SPACE 3

Catalogue number:84003

User age:	up to 14 years
Max. free fall height :	0,93 m
Product dimensions (length x width x height)	4,29 x 2,15 x 2,99 m
Impact area dimensions (length x width)	7,75 x 4,91 m



Product dimensions

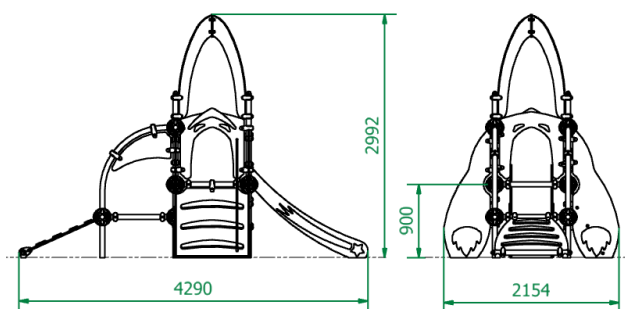

Impact area dimensions

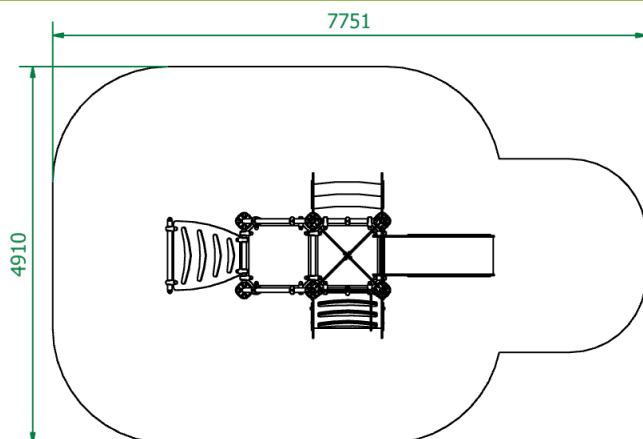

Permissible impact attenuating surfacing

- Turf / topsoil
- Bark – grain size 20 do 80 mm, min. depth 200 mm + 100mm (for displacement)
- Woodchip – grain size 5 do 30 mm, min. depth 200mm + 100mm (for displacement)
- Sand – grain size 0,2 do 2 mm, min. depth 200mm + 100mm (for displacement)
- Gravel – grain size 2 do 8 mm, min. depth 200 mm + 100mm (for displacement)
- Synthetic surfaces in accordance whit tested HIC (EN 1177)

The impact attenuating surfacing shall be installed over the entire impact area.

Technical description

- Construction made of stainless steel and plastic connectors.
- HDPE and HPL construction components
- Non-slip, waterproof plywood platforms
- Stainless steel & HDPE slide
- The set includes foundations made of concrete class C25/30