

INSTRUKCJA MONTAŻU

INSTALLATION INSTRUCTION

Wydanie <i>Edition</i>	01
Data <i>Date</i>	18-11-2013

POMOST MISIE ŁAPKI

Teddy bear paws bridge

Numer katalogowy
catalogue number **81204**











1. Informacje techniczne

Technical information

Grupa wiekowa <i>User age</i>	do 14 lat <i>up to 14 y.o.</i>
Maksymalna wysokość swobodnego upadku <i>Max. free fall height</i>	0,43 m
Największa część <i>Largest part</i>	Słup <i>Pole</i>
Wymiary największej części <i>Largest part dimensions</i>	ø60,3 mm x 206 cm
Masa największej części <i>Largest part weight</i>	11 kg
Masa największego fundamentu <i>Largest foundation weight</i>	60 kg
Zgodność z normami <i>Accordance with standards</i>	EN 1176-1:2008



2. Wykaz narzędzi

Tools list

1. Wykaz części

Parts list

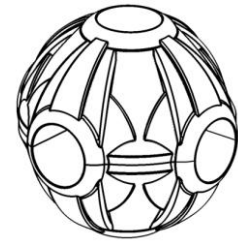
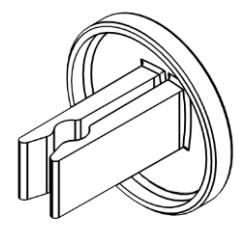
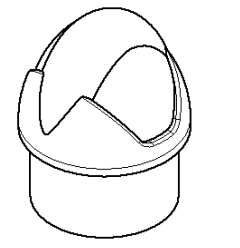
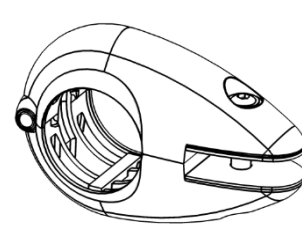
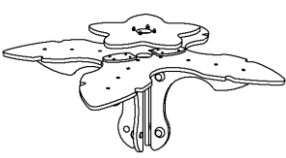
			
KL*	Szt. Pcs 8	ZS-1*	Szt. Pcs 26
		ZS-2	Szt. Pcs 5
		UC-1	Szt. Pcs 12
			
PAL	Szt. Pcs 1	PLT-2	Szt. Pcs 2
		LC-1	Szt. Pcs 16
		TRP	Szt. Pcs 2
			
SLP	Szt. Pcs 5	B300x4	Szt. Pcs 9
		B500x4	Szt. Pcs 5

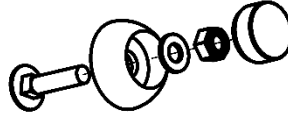
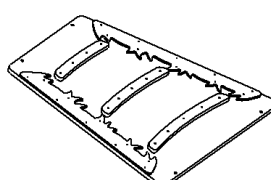
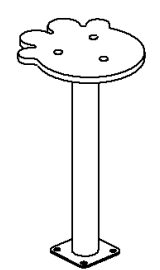
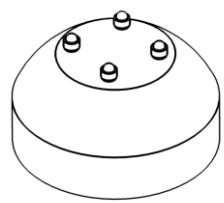
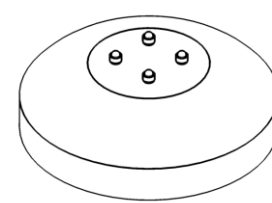
* patrz – instrukcja szczegółowa
see – detailed instructions

Rury
pipes

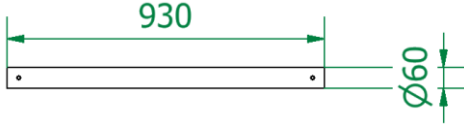
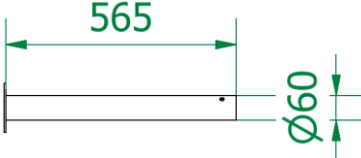
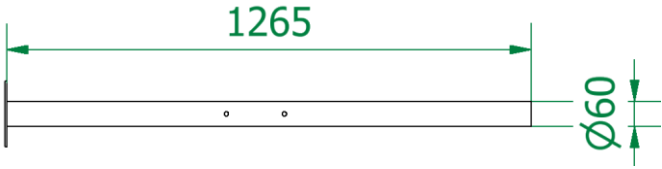
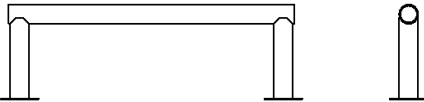
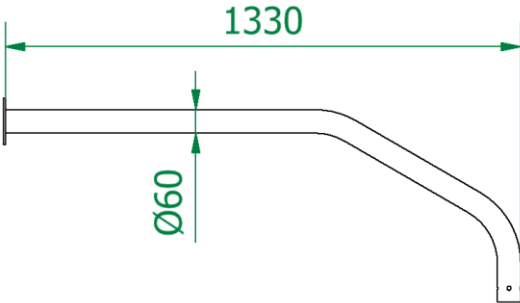
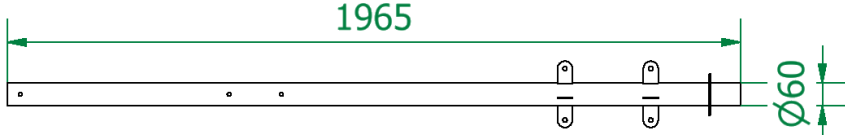
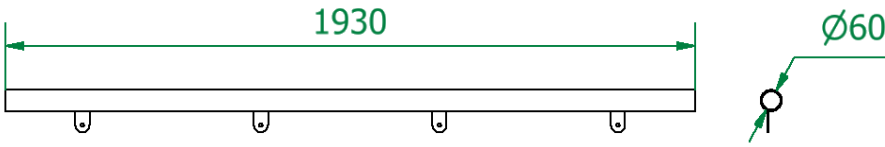
RO-1	Szt./Pcs	2	
			
RO-2	Szt./Pcs	1	
			
RO-3	Szt./Pcs	3	
			
RO-4	Szt./Pcs	2	
			
RO-5	Szt./Pcs	1	
			
RO-6	Szt./Pcs	1	
			
RO-7	Szt./Pcs	2	
			

2. Fundamenty i powierzchnia zderzenia

Foundations and impact area

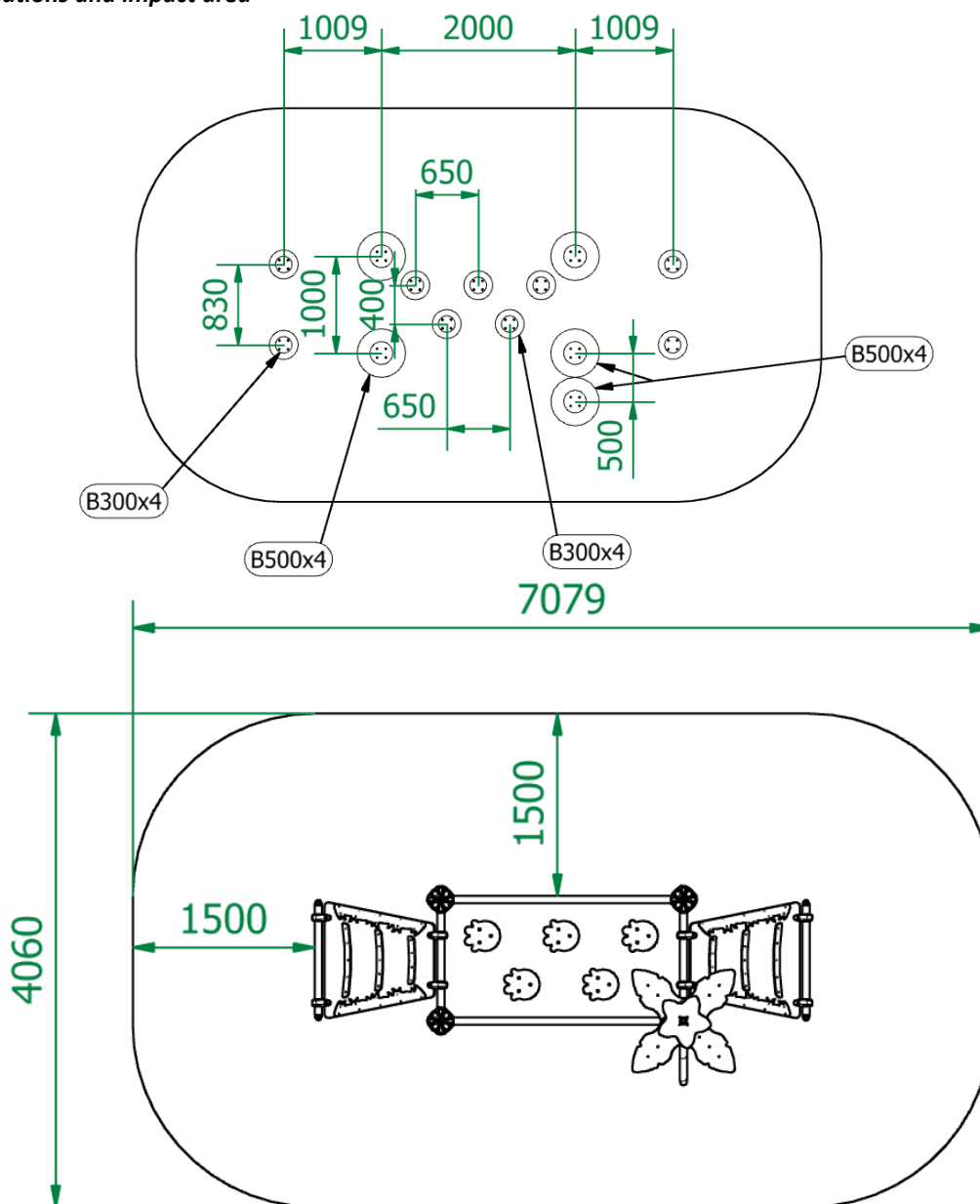

*rozmiary i montaż fundamentów w instrukcji szczegółowej
dimensions and foundation installation in detailed instruction

3. Konstrukcja Structure

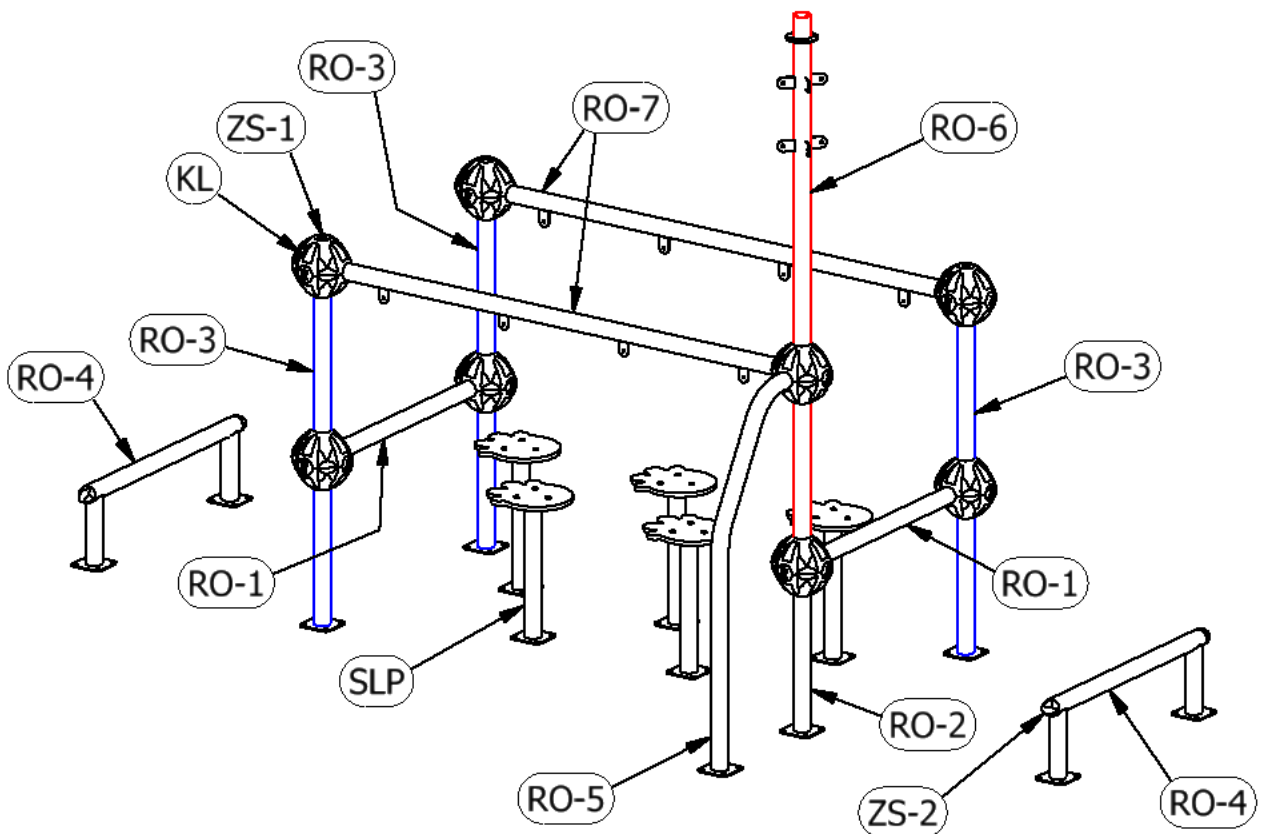
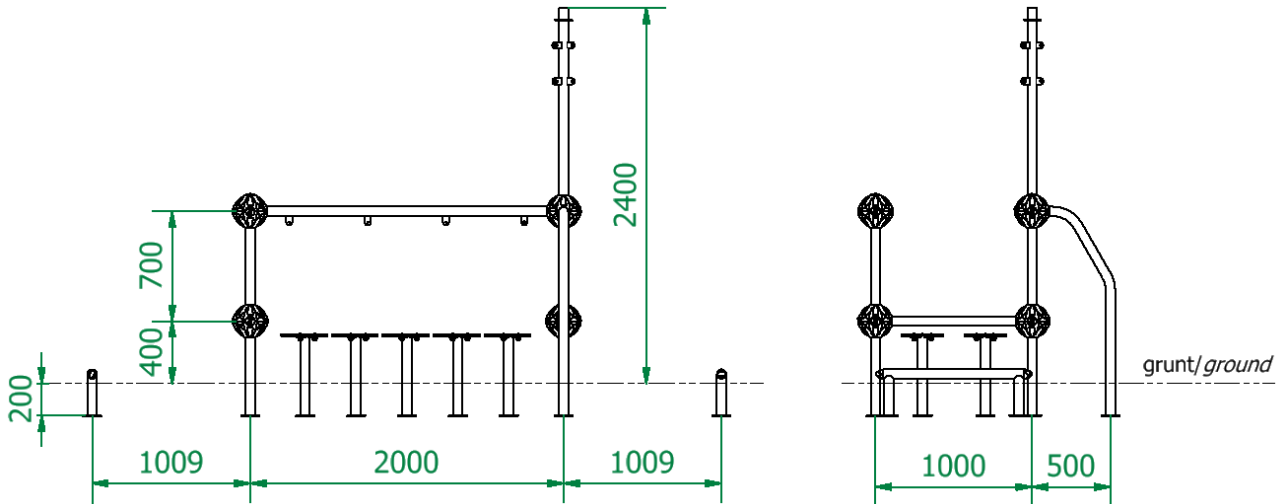

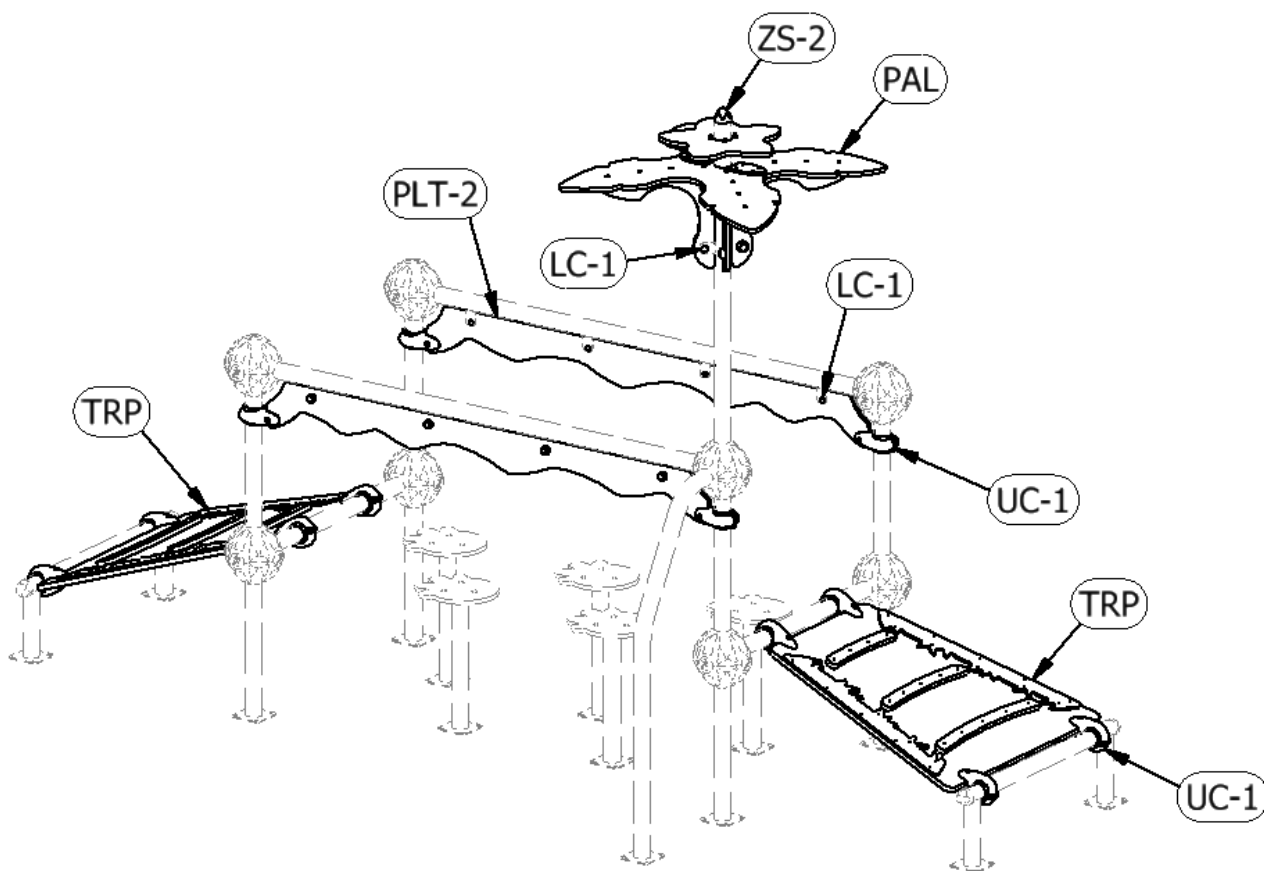

Wkręty/
screws

