

INSTRUKCJA MONTAŻU

INSTALLATION INSTRUCTION

Wydanie <i>Edition</i>	01
Data <i>Date</i>	18-03-2014

RÓWNOWAŻNIA POTRÓJNA

TRIPPLE BALANCE BEAM

Numer katalogowy
catalogue number **81252**











1. Informacje techniczne

Technical information

Grupa wiekowa <i>User age</i>	6 - 14
Maksymalna wysokość swobodnego upadku <i>Max. free fall height</i>	1,6 m
Największa część <i>Largest part</i>	Słup <i>Pole</i>
Wymiary największej części <i>Largest part dimensions</i>	215 x 18 x 18,mm cm
Masa największej części <i>Largest part weight</i>	12 kg
Masa największego fundamentu <i>Largest foundation weight</i>	60 kg
Zgodność z normami <i>Accordance with standards</i>	EN 1176-1:2008



2. Wykaz narzędzi

Tools list

1. Wykaz części

Parts list

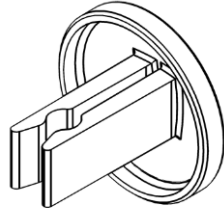
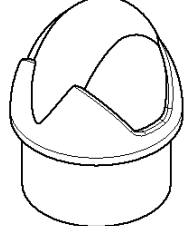
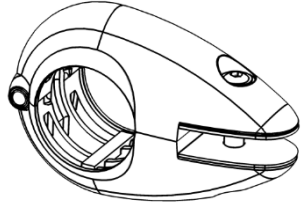
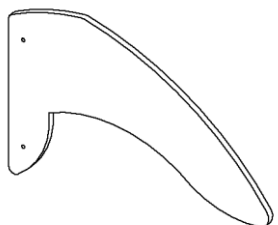
							
KL*	Szt. Pcs 5	ZS-1*	Szt. Pcs 10	ZS-2	Szt. Pcs 1	UC-1	Szt. Pcs 12
							
PAL	Szt. Pcs 4	PLT-1	Szt. Pcs 2	PLT-2	Szt. Pcs 2	PLT-3	Szt. Pcs 4
							
LC-1	Szt. Pcs 28	B500x4	Szt. Pcs 5				

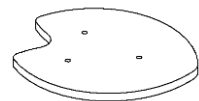
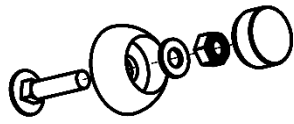
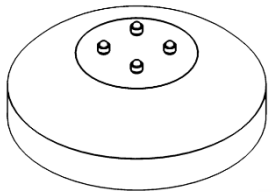
* patrz – instrukcja szczegółowa
see – detailed instructions

Rury
pipes

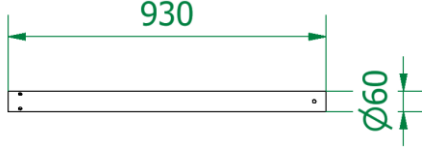
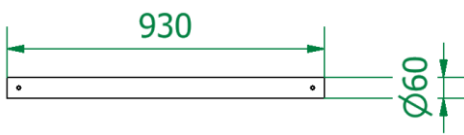
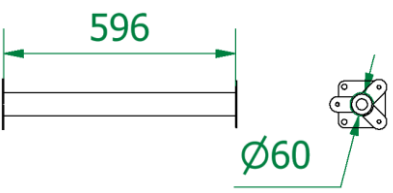
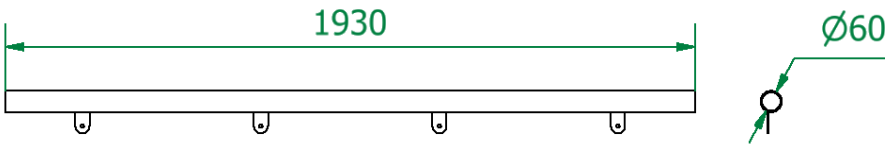
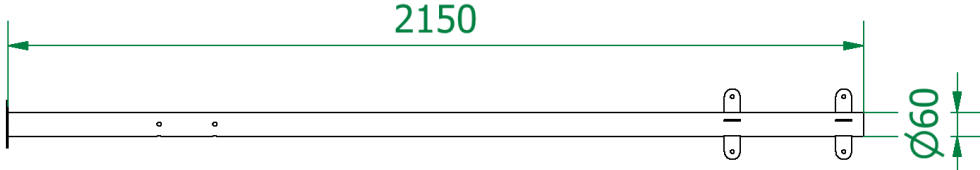
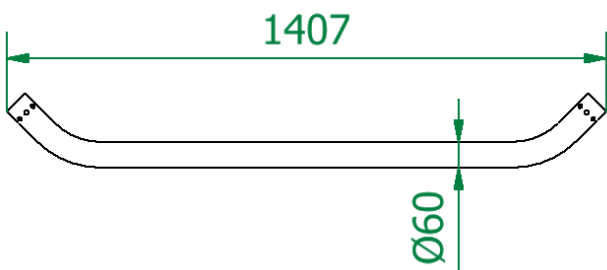
RO-1	Szt./Pcs	1	
			
RO-2	Szt./Pcs	1	
			
RO-3	Szt./Pcs	4	
			
RO-4	Szt./Pcs	2	
			
RO-5	Szt./Pcs	1	
			
RO-6	Szt./Pcs	1	
			

3. Fundamenty i powierzchnia zderzenia *Foundations and impact area*

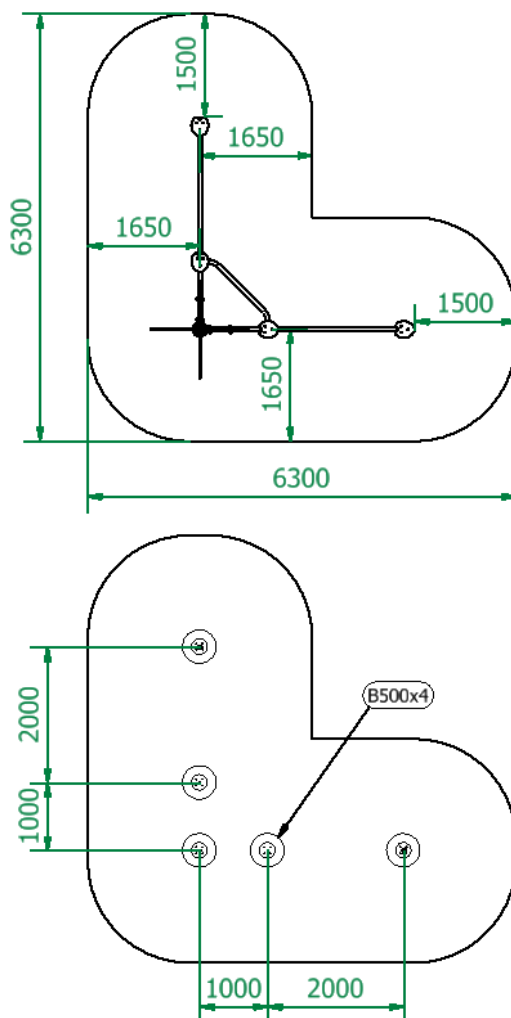

*rozmiary i montaż fundamentów w instrukcji szczegółowej
dimensions and foundation installation in detailed instruction

