

INSTRUKCJA MONTAŻU

INSTALLATION INSTRUCTION

Wydanie <i>Edition</i>	01
Data <i>Date</i>	22-04-2014

OCEAN 2

OCEAN 2

Numer katalogowy
catalogue number **82002**

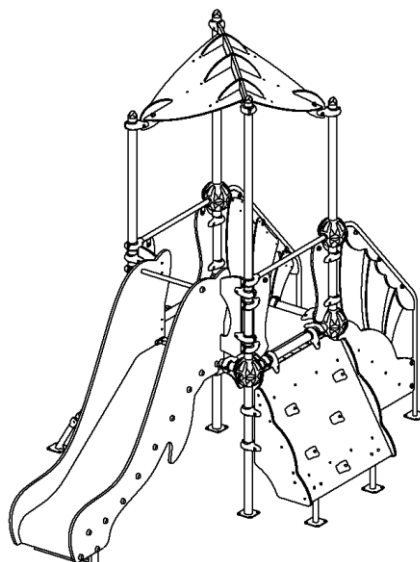





1. Informacje techniczne

Technical information

Grupa wiekowa <i>User age</i>	0-14
Maksymalna wysokość swobodnego upadku <i>Max. free fall height</i>	0,93 m
Największa część <i>Largest part</i>	Zjeżdżalnia <i>Slide</i>
Wymiary największej części <i>Largest part dimensions</i>	2,33 x 1,04 x 0,57 m
Masa największej części <i>Largest part weight</i>	70 kg
Masa największego fundamentu <i>Largest foundation weight</i>	60 kg
Zgodność z normami <i>Accordance with standards</i>	EN 1176-1:2008 EN 1176-3:2008



2. Wykaz narzędzi

Tools list

					
			 x2		

3. Wykaz części

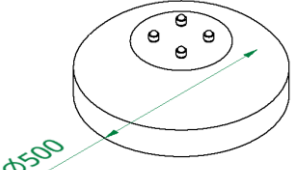
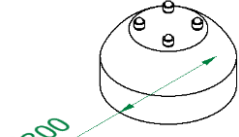
Parts list

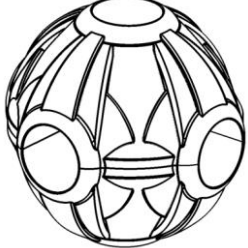
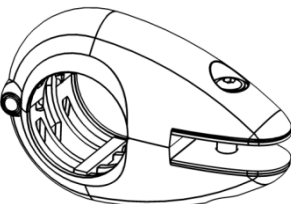
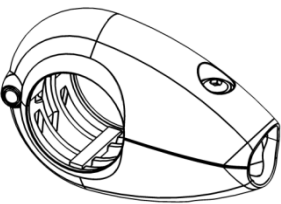
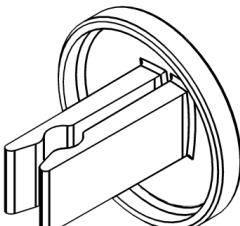
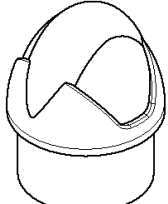
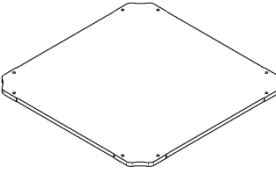
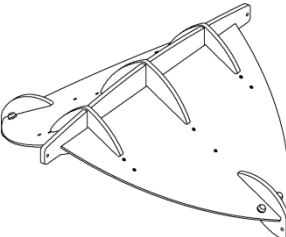
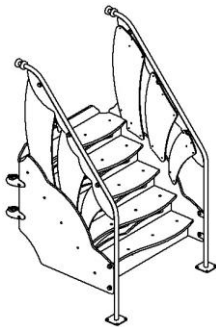
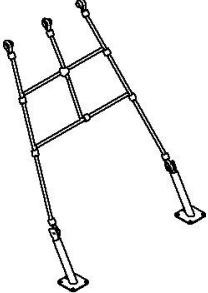
							
B1	Szt. Pcs 2	B2	Szt. Pcs 8	B3	Szt. Pcs 1	KL*	Szt. Pcs 6
							
UC-1*	Szt. Pcs 35	UC-3*	Szt. Pcs 2	ZS-1*	Szt. Pcs 11	ZS-2	Szt. Pcs 4
							
PK-1000*	Szt. Pcs 1	D2-O	Szt. Pcs 1	SCH	Szt. Pcs 1	WL	Szt. Pcs 1

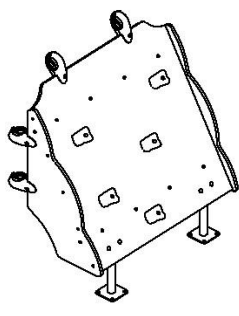
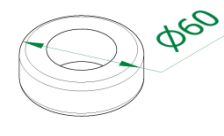
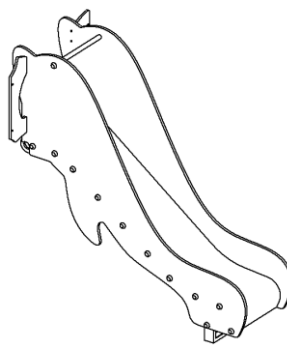
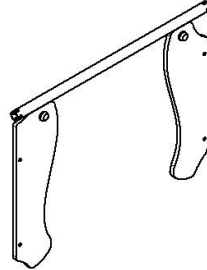
											
WW	Szt. Pcs	1	PR	Szt. Pcs	6	ZJ	Szt. Pcs	1	PRZ	Szt. Pcs	2

* patrz – instrukcja szczegółowa
see – detailed instruction

Rury
pipes

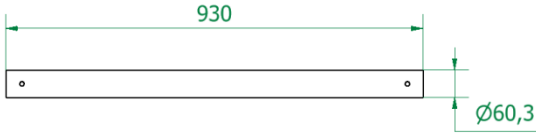
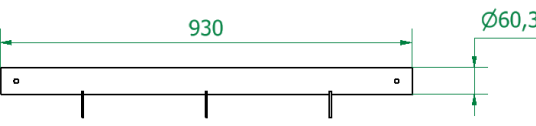
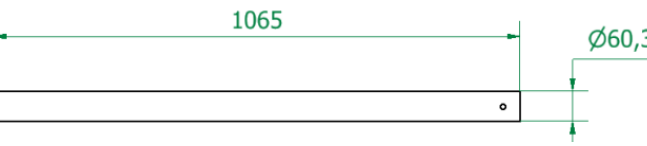
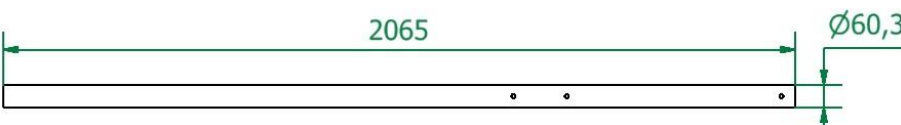
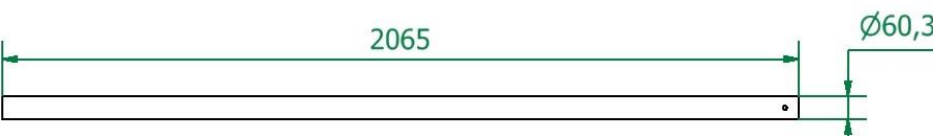
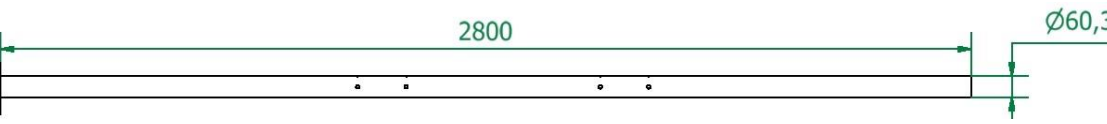
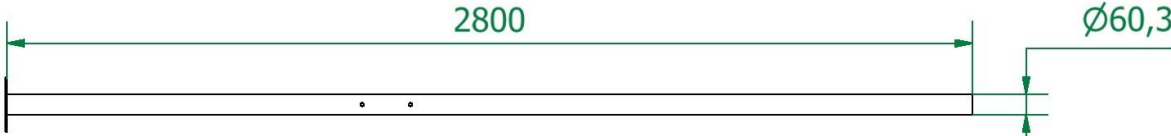
RO-1	Szt./Pcs	3
		
RO-2	Szt./Pcs	1
		
RO-3	Szt./Pcs	2
		
RO-4	Szt./Pcs	1
		
RO-5	Szt./Pcs	1
		
RO-6	Szt./Pcs	1
		
RO-7	Szt./Pcs	1
		

4. Fundamenty i powierzchnia zderzenia

Foundations and impact area

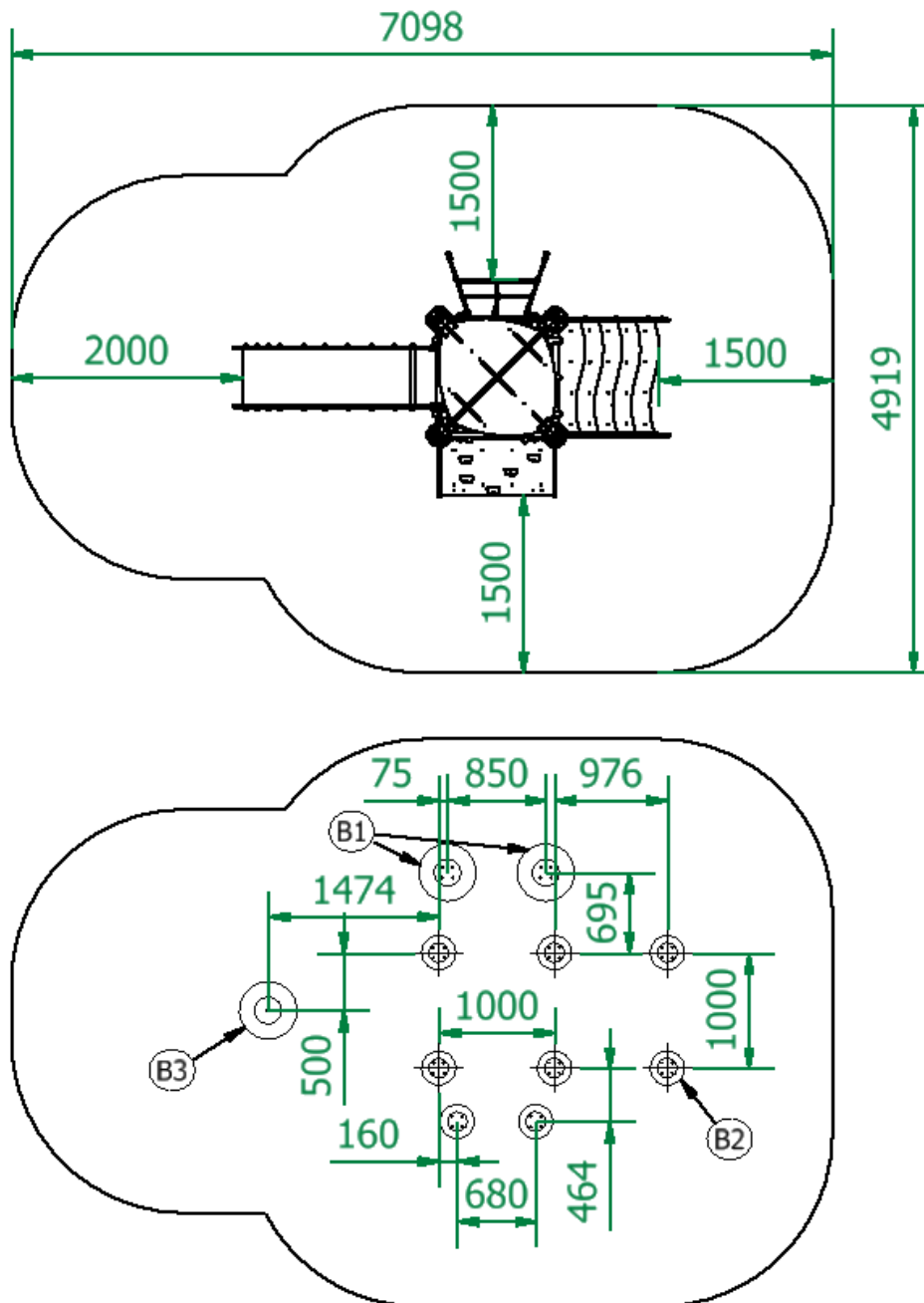

5. Rama Frame

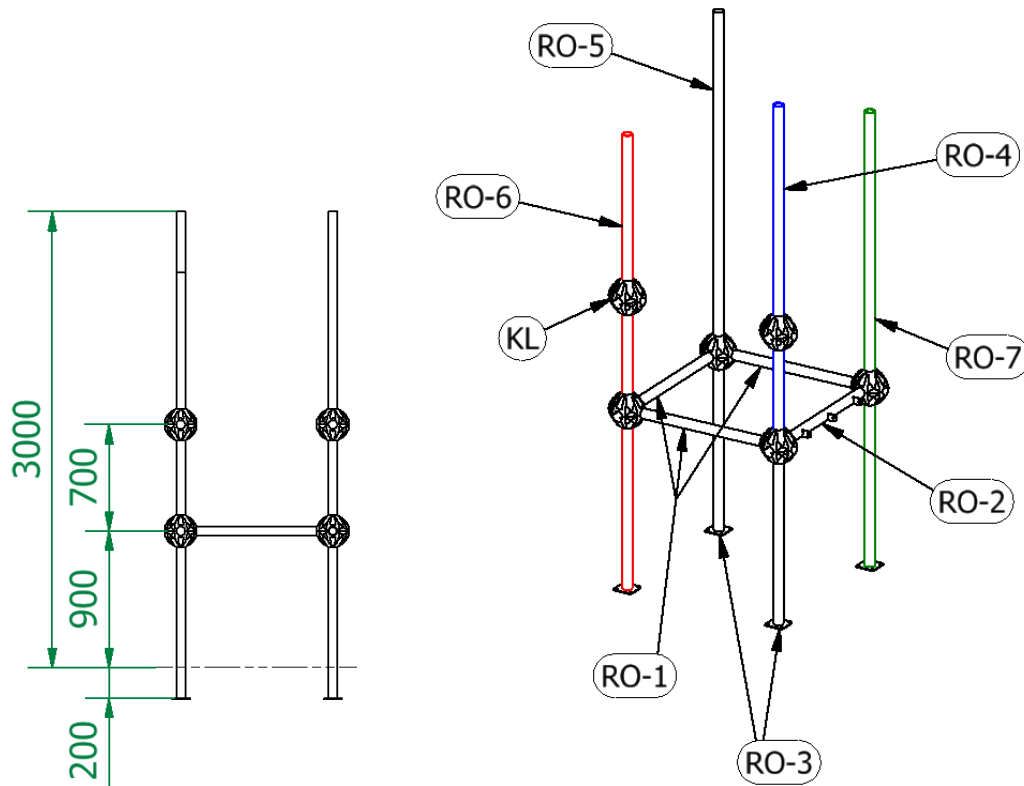

6. Podest Platform

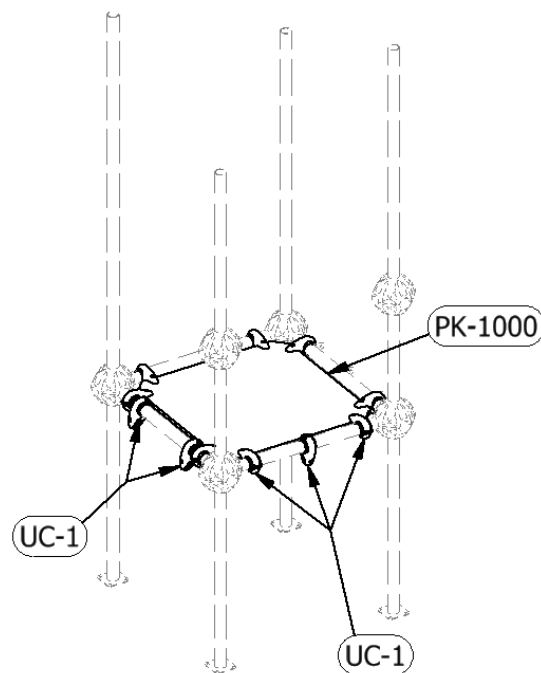

Zalecane wstępne nałożenie uchwytów (bez dokręcania)
Recommended initial assembly of holders (without tightening)

7. Podzespoły Components

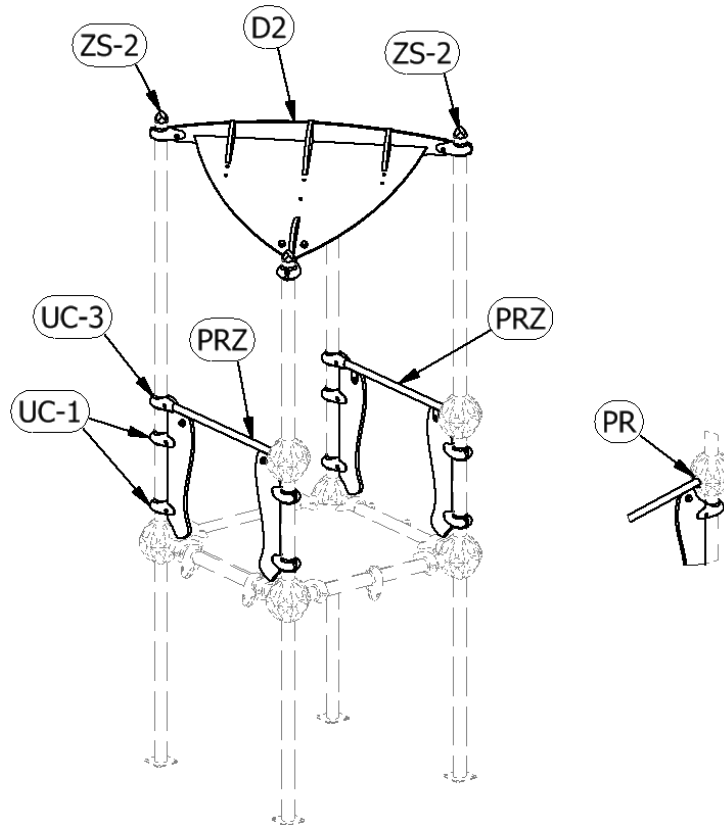

Zwrócić szczególną uwagę na rozstaw otworów montażowych w płytach PRZ
Pay attention to the mounting holes in the boards PRZ

