

INSTRUKCJA MONTAŻU

INSTALLATION INSTRUCTION

Wydanie <i>Edition</i>	01
Data <i>Date</i>	22-05-2017

OCEAN 9

OCEAN 9

Numer katalogowy
catalogue number **82009**













1. Informacje techniczne

Technical information

Grupa wiekowa <i>User age</i>	do 14 up to 14
Maksymalna wysokość swobodnego upadku <i>Max. free fall height</i>	0,93 m
Największa część <i>Largest part</i>	Zjeżdżalnia <i>Slide</i>
Wymiary największej części <i>Largest part dimensions</i>	2,33 x 1,04 x 0,57 m
Masa największej części <i>Largest part weight</i>	70 kg
Masa największego fundamentu <i>Largest foundation weight</i>	60 kg
Zgodność z normami <i>Accordance with standards</i>	EN 1176-1:2008 EN 1176-3:2008

2. Wykaz narzędzi



Tools list

3. Wykaz części

Parts list

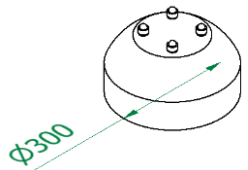
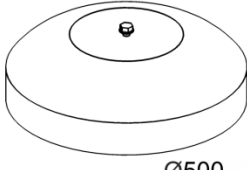
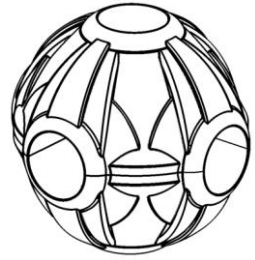
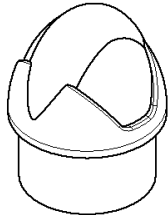
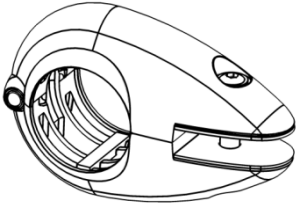
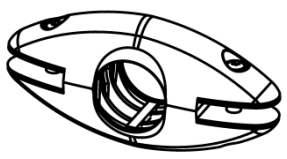
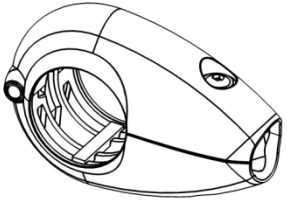
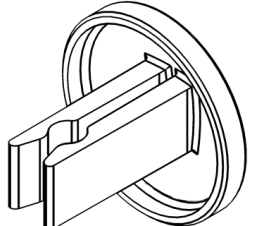
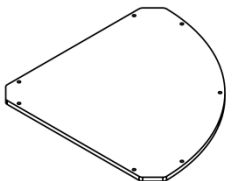
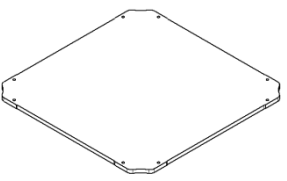
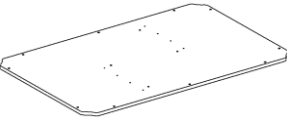
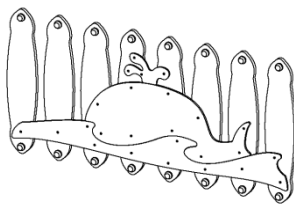
			
B2	B3	KL*	ZS-2
Szt. Pcs 11	Szt. Pcs 1	Szt. Pcs 13	Szt. Pcs 2
			
UC-1*	UC-2*	UC-3*	ZS-1*
Szt. Pcs 41	Szt. Pcs 4	Szt. Pcs 1	Szt. Pcs 29
			
PL-1000	PK-1000*	PzP-1500	PzP-B
Szt. Pcs 1	Szt. Pcs 1	Szt. Pcs 1	Szt. Pcs 2

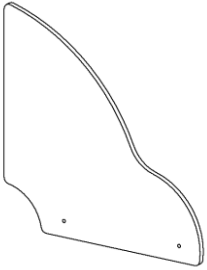
											
PzP-P	Szt. Pcs	2	SC-1	Szt. Pcs	8	PAL	Szt. Pcs	1	SW	Szt. Pcs	1
											
SCH	Szt. Pcs	1	ZJ*	Szt. Pcs	1	PRZ-1	Szt. Pcs	1	XO	Szt. Pcs	1

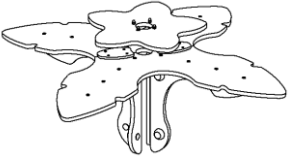
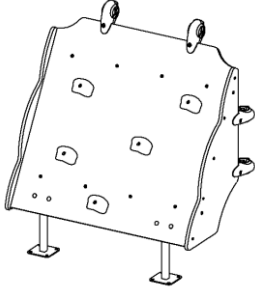
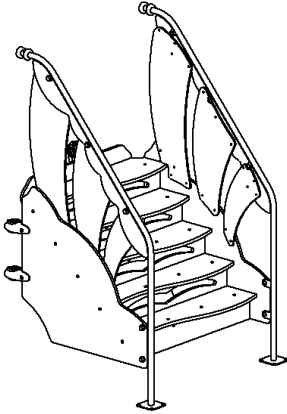
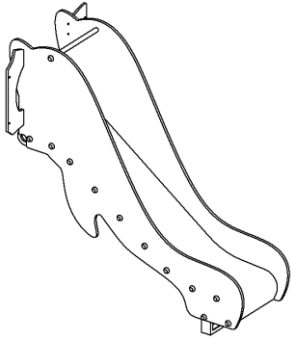
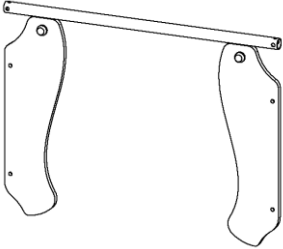
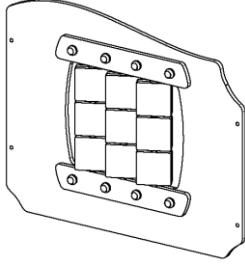
* patrz – instrukcja szczegółowa
see – detailed instruction

**Rury
pipes**

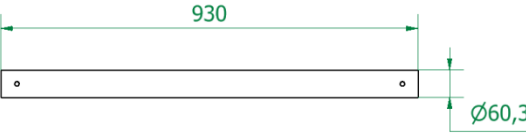
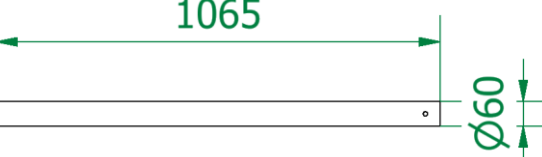
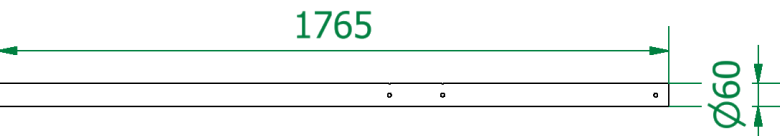
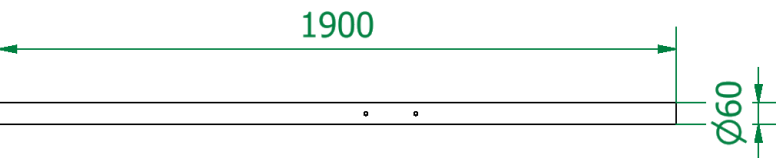
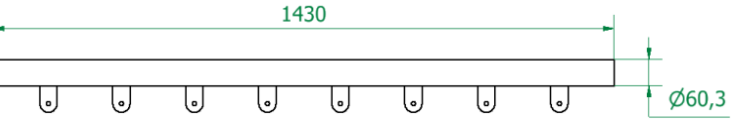
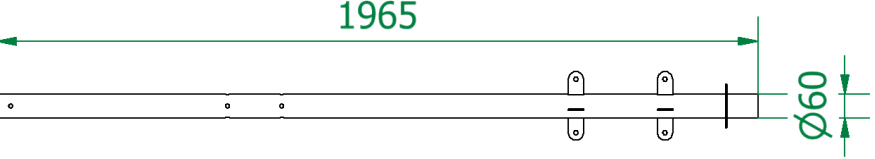
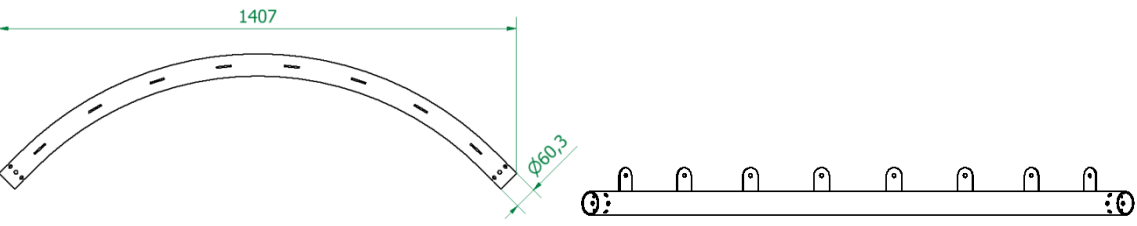
RO-1	Szt./Pcs	6	
			
RO-2	Szt./Pcs	1	
			
RO-3	Szt./Pcs	5	
			
RO-4	Szt./Pcs	1	
			
RO-5	Szt./Pcs	4	
			
RO-6	Szt./Pcs	1	
			
RO-7	Szt./Pcs	2	
			

4. Etapy instalacji

Installation steps

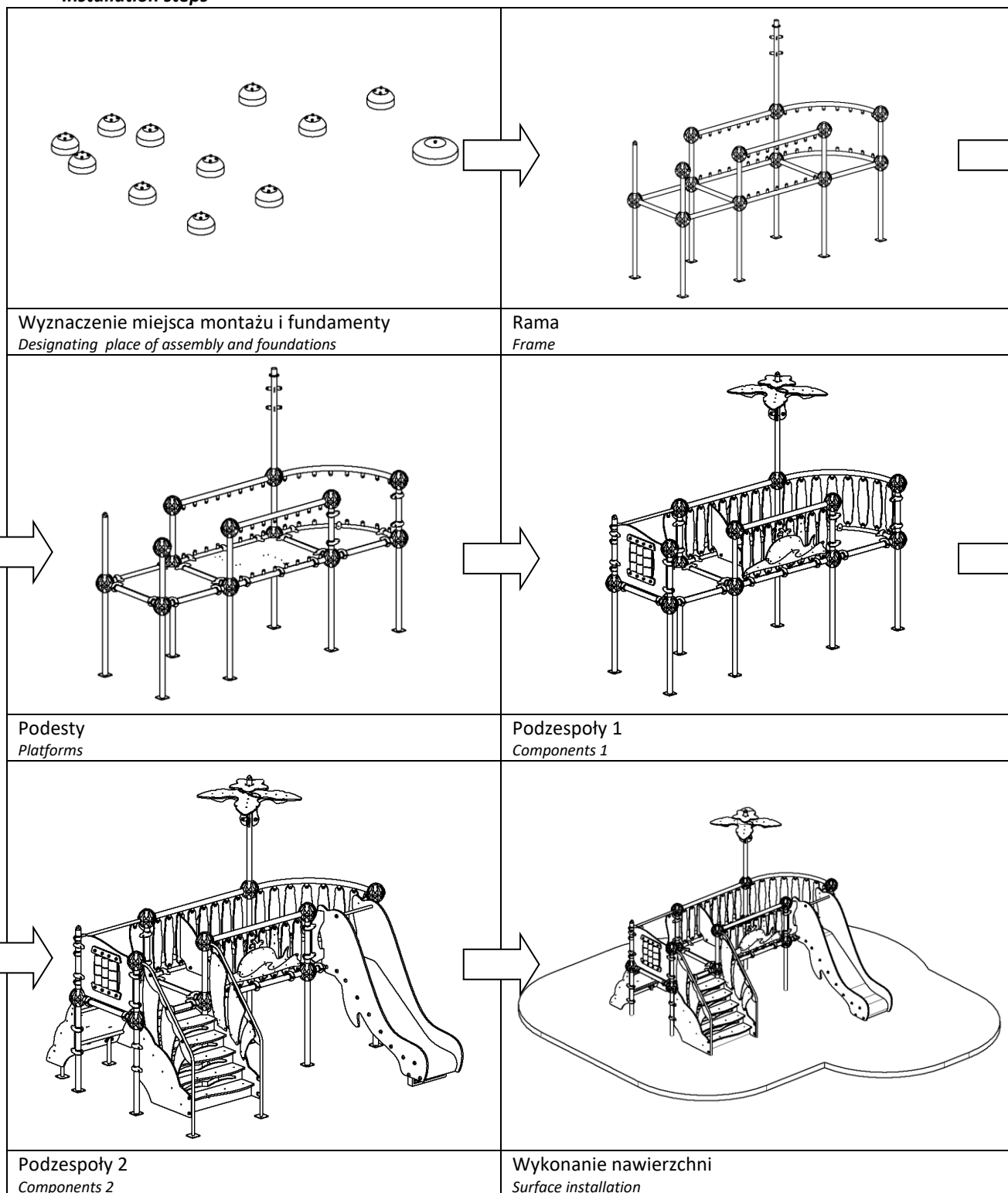

5. Fundamenty i powierzchnia zderzenia

Foundations and impact area

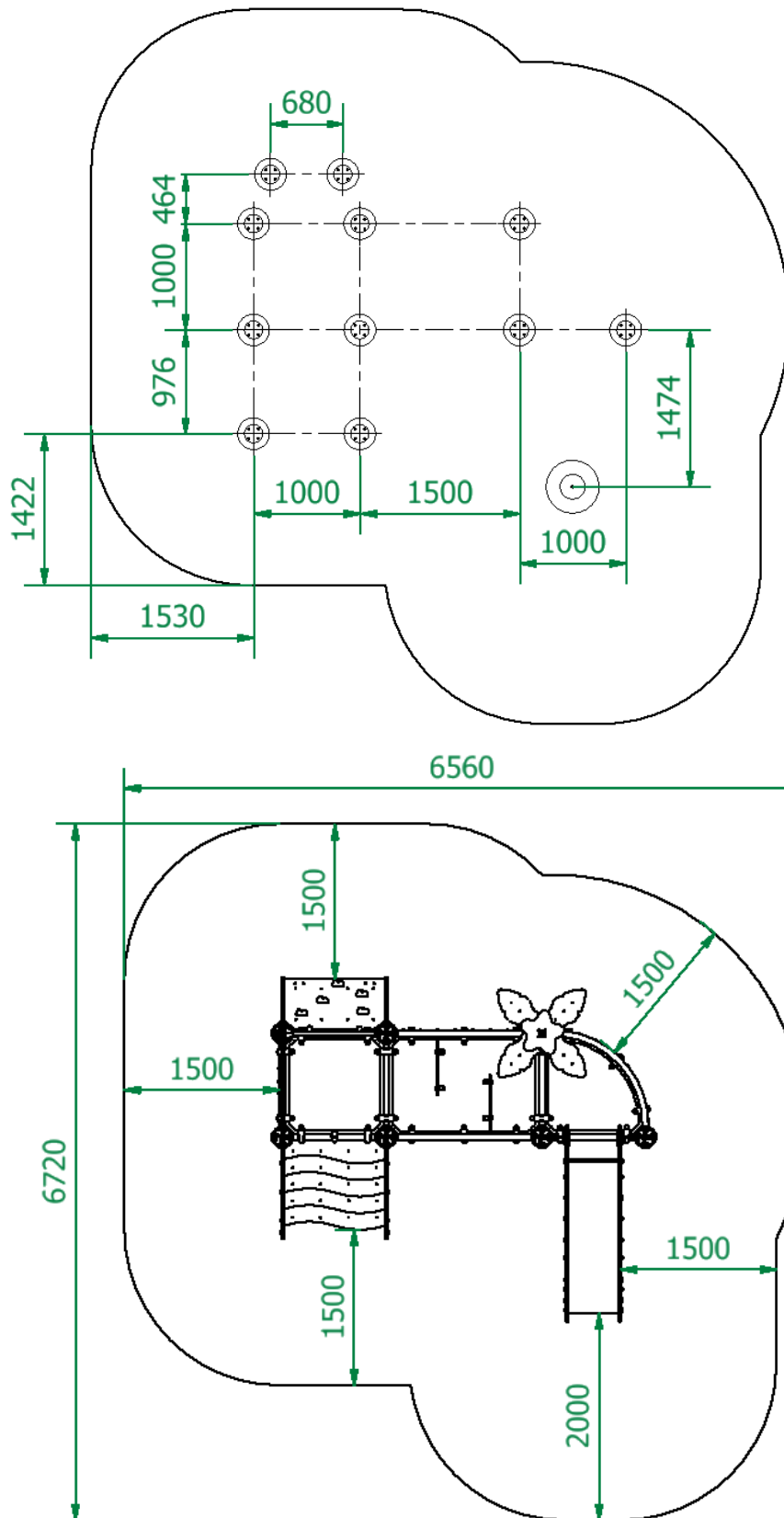

6. Rama Frame

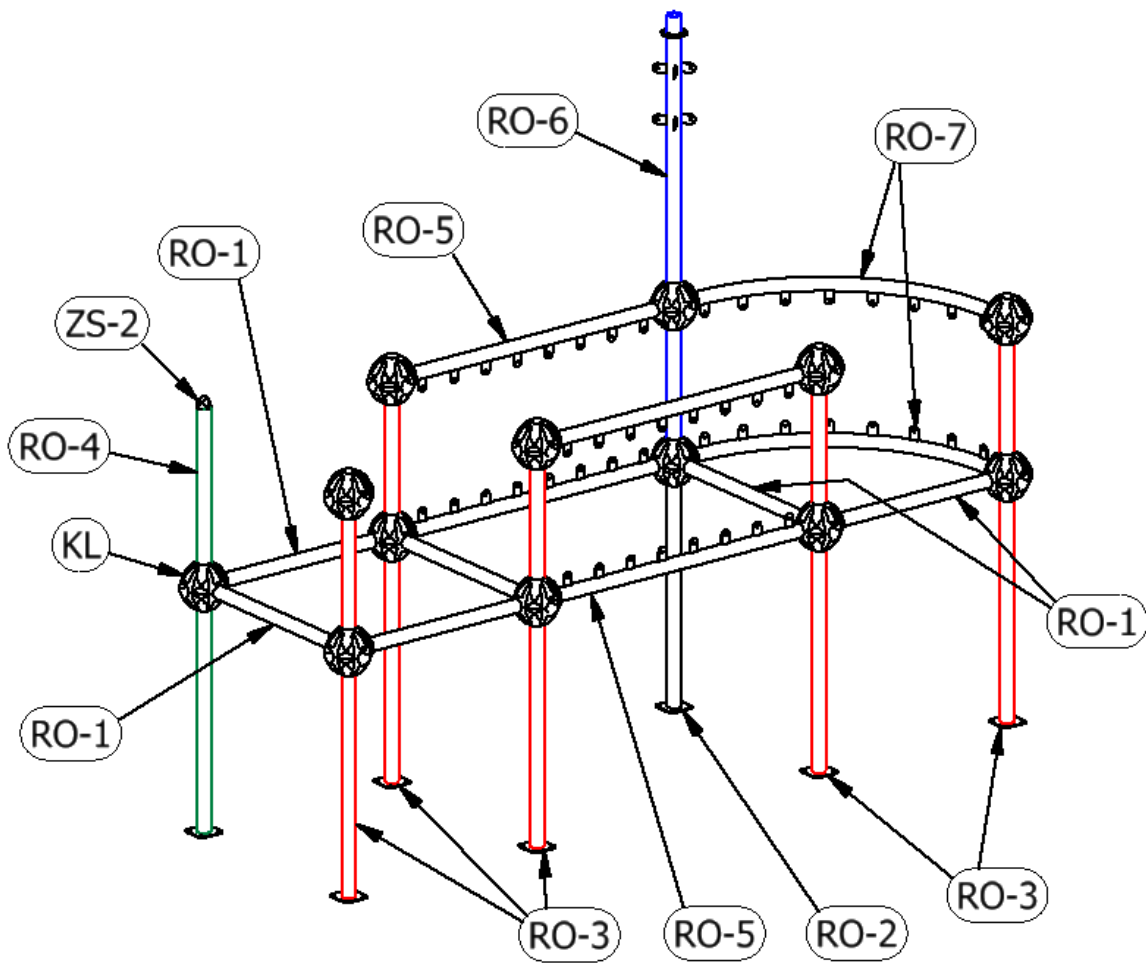
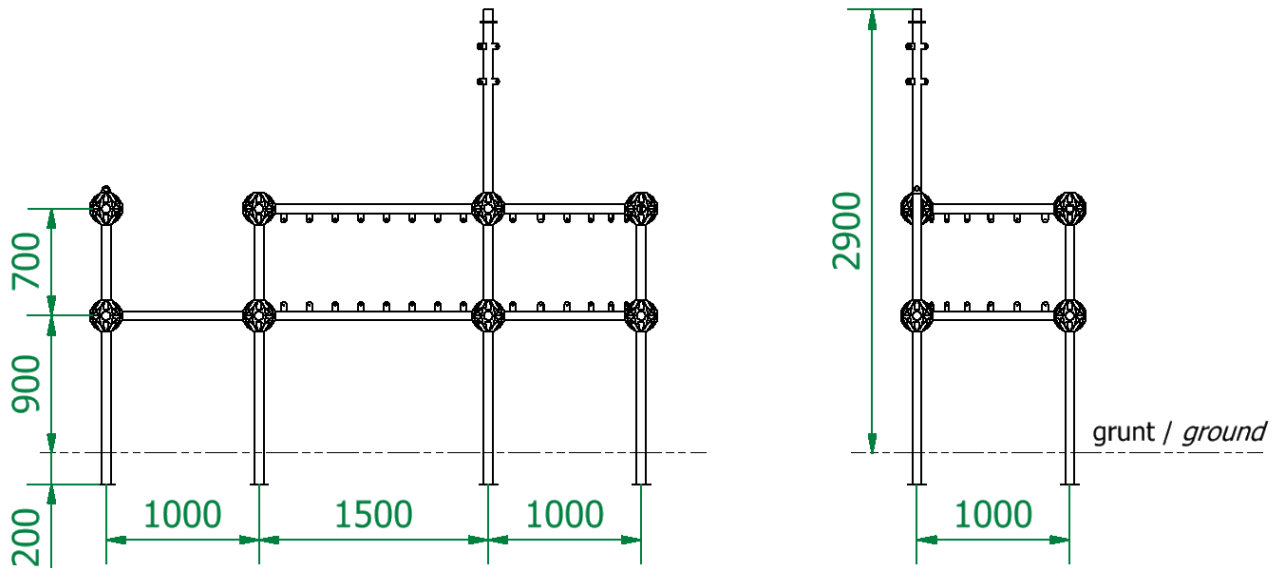

7. Podesty Platforms

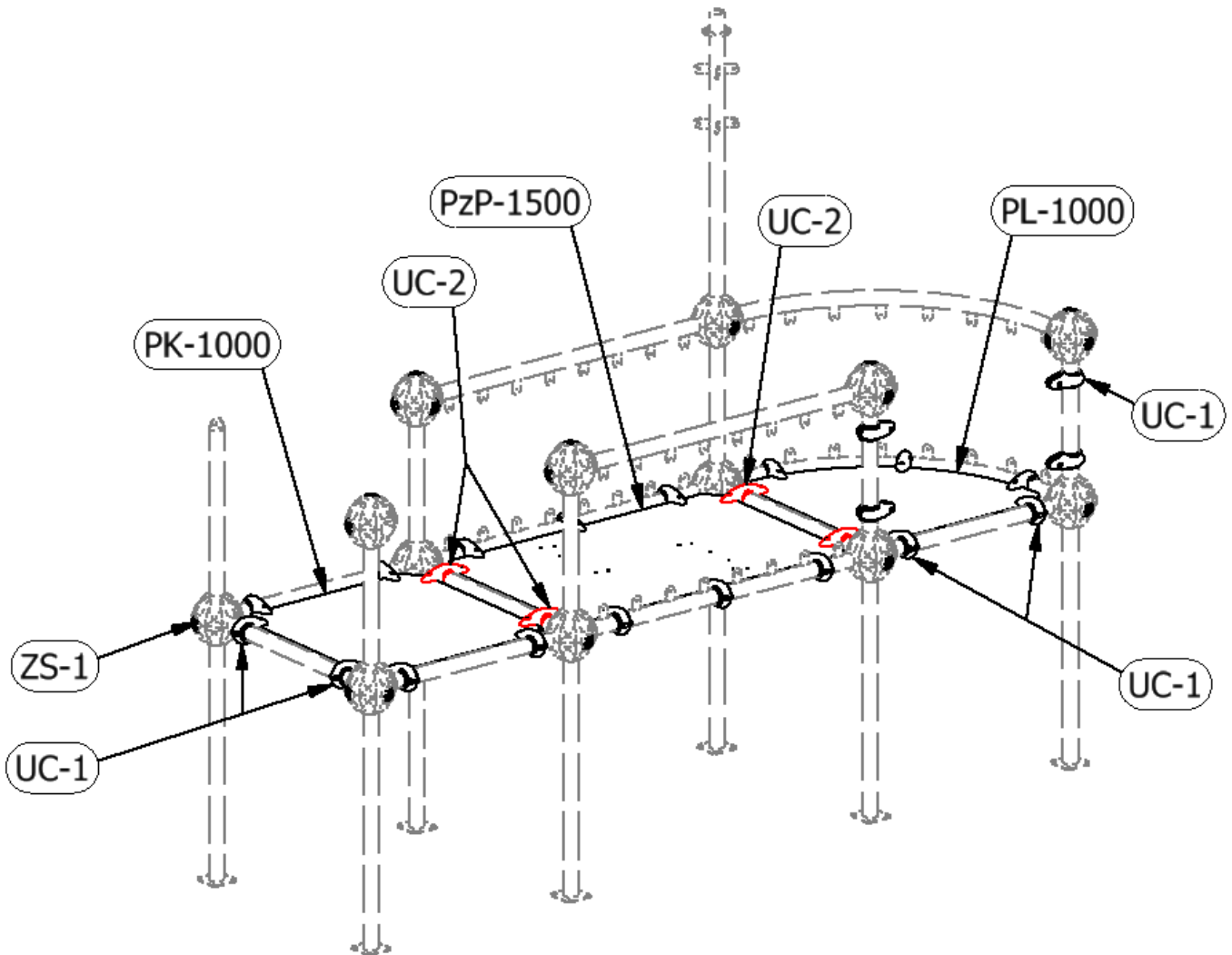

Zalecane wstępne nałożenie uchwytów (bez dokręcania)
Recommended initial assembly of holders (without tightening)

8. Podzespoły Components

