

INSTRUKCJA MONTAŻU

INSTALLATION INSTRUCTION

Wydanie <i>Edition</i>	01
Data <i>Date</i>	03-03-2020

OCEAN 11

OCEAN 11

Numer katalogowy
catalogue number **82011**











1. Informacje techniczne

Technical information

Grupa wiekowa <i>User age</i>	0-14
Maksymalna wysokość swobodnego upadku <i>Max. free fall height</i>	0,93 m
Największa część <i>Largest part</i>	Zjeżdżalnia <i>Slide</i>
Wymiary największej części <i>Largest part dimensions</i>	2,33 x 1,04 x 0,57 m
Masa największej części <i>Largest part weight</i>	70 kg
Masa największego fundamentu <i>Largest foundation weight</i>	60 kg
Zgodność z normami <i>Accordance with standards</i>	EN 1176-1 EN 1176-3

2. Wykaz narzędzi

Tools list

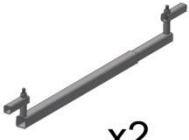
					
			 x2		

3. Wykaz części

Parts list

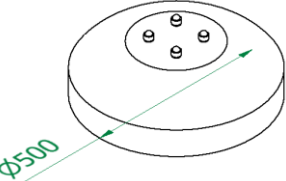
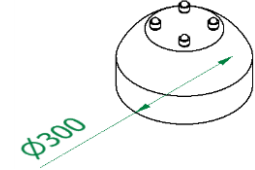
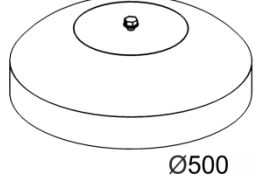
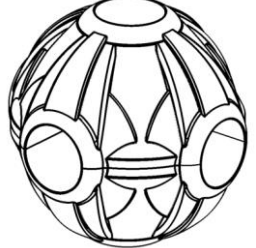
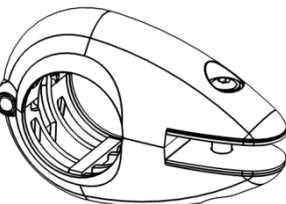
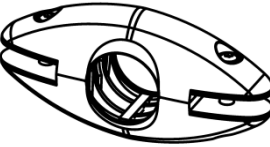
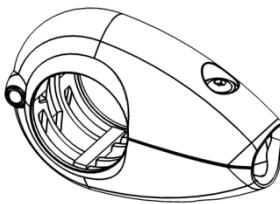
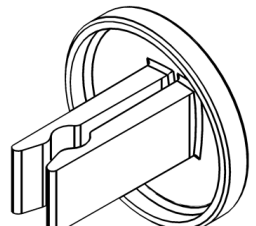
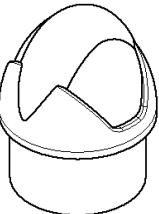
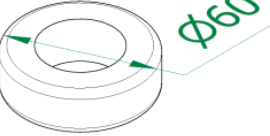
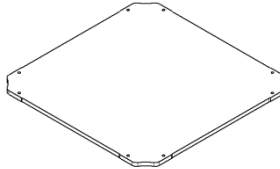
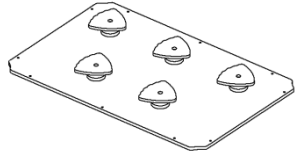
			
B1	B2	B3	KL*
Szt. Pcs 2	Szt. Pcs 20	Szt. Pcs 1	Szt. Pcs 25
			
UC-1*	UC-2*	UC-3*	ZS-1*
Szt. Pcs 76	Szt. Pcs 9	Szt. Pcs 7	Szt. Pcs 54
			
ZS-2	RING	PK-1000*	PzM-A
Szt. Pcs 13	Szt. Pcs 3	Szt. Pcs 5	Szt. Pcs 1

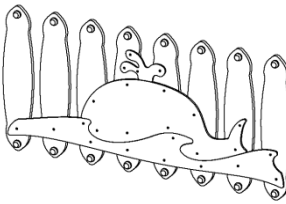
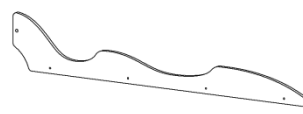
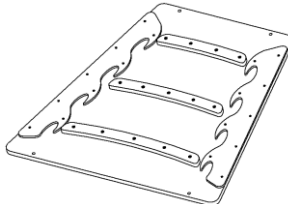
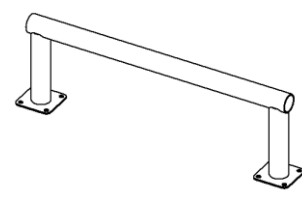
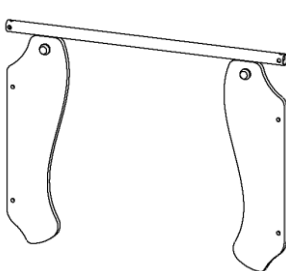
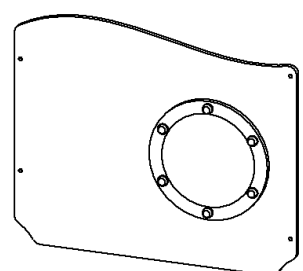
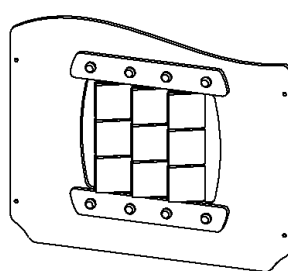
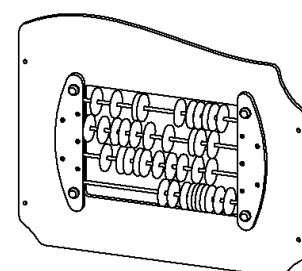
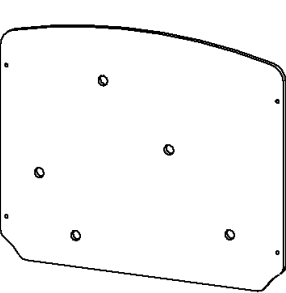
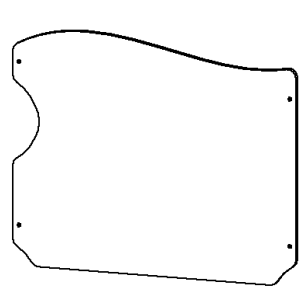
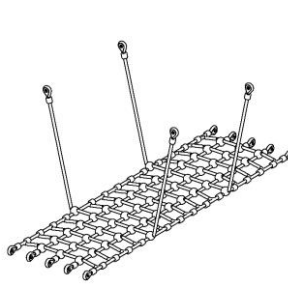
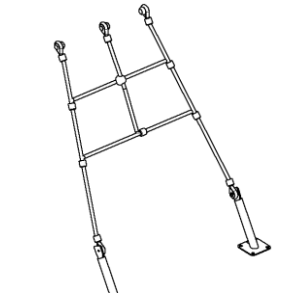
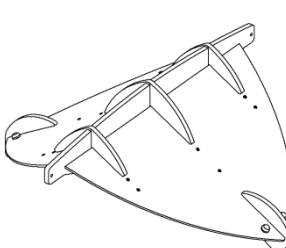
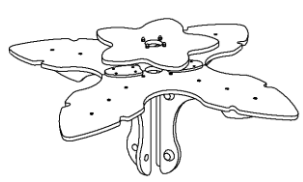
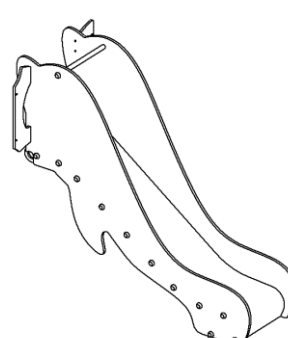
											
PzM-B	Szt. Pcs	2	PzM-C	Szt. Pcs	2	TRP-A	Szt. Pcs	2	TRP-B	Szt. Pcs	2
											
PRZ-A1-A1	Szt. Pcs	1	BAR-BUL	Szt. Pcs	1	BAR-XO	Szt. Pcs	1	BAR-LIC	Szt. Pcs	1
											
BAR-LAB	Szt. Pcs	1	BAR-1	Szt. Pcs	1	ML	Szt. Pcs	1	WL	Szt. Pcs	1
											
D2	Szt. Pcs	1	PALM	Szt. Pcs	1	ZJ	Szt. Pcs	1			

* patrz – instrukcja szczegółowa
see – detailed instruction

Rury
pipes

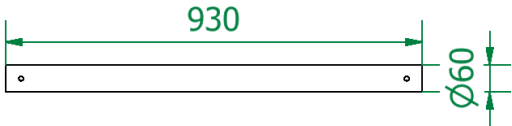
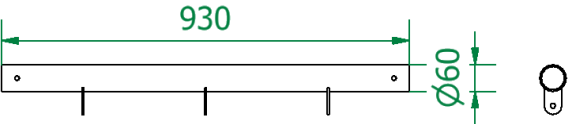
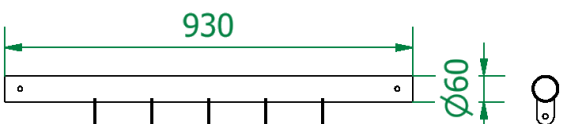
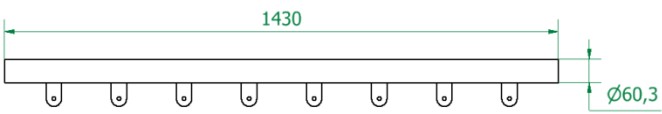
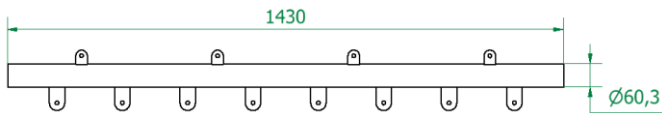
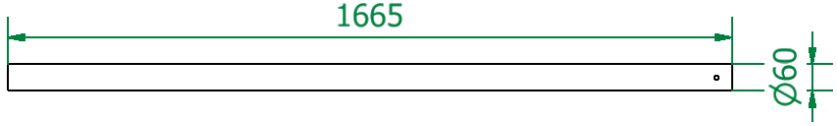
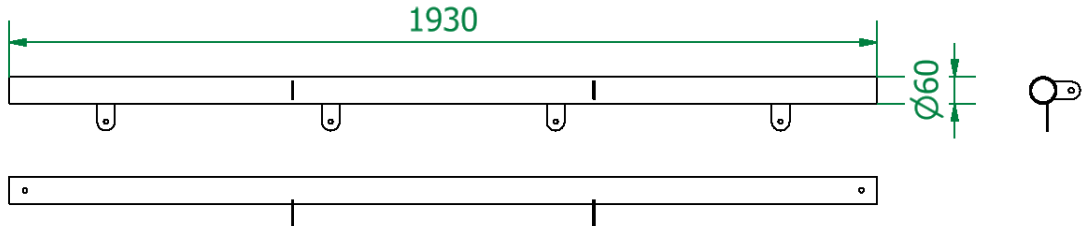
Model	Szt./Pcs	Count	
RO-884	Szt./Pcs	3	
RO-930	Szt./Pcs	16	
RO-930B	Szt./Pcs	1	
RO-930C	Szt./Pcs	2	
RO-1430A	Szt./Pcs	2	
RO-1430B	Szt./Pcs	2	
RO-1665	Szt./Pcs	1	
RO-1930A	Szt./Pcs	2	

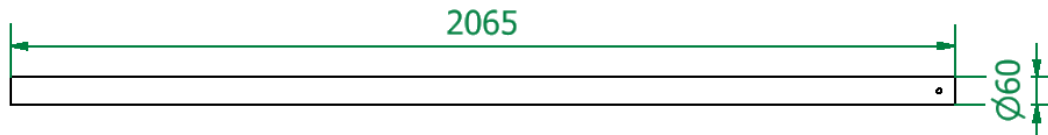
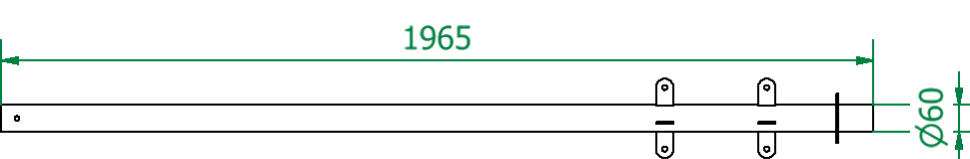
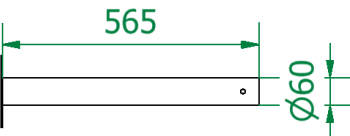
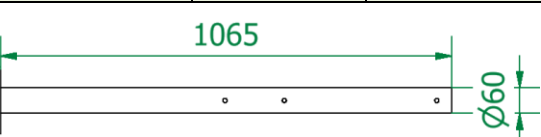
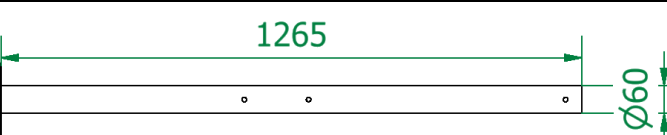
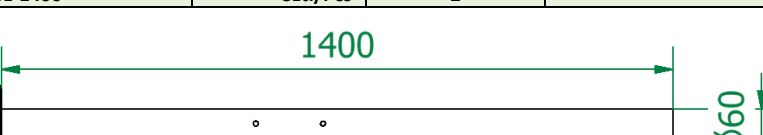
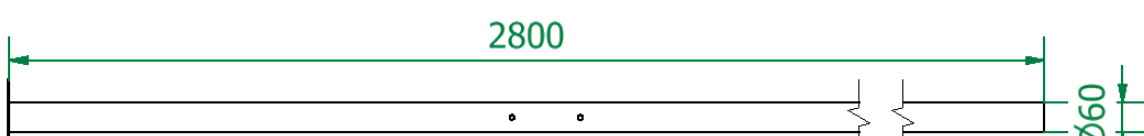
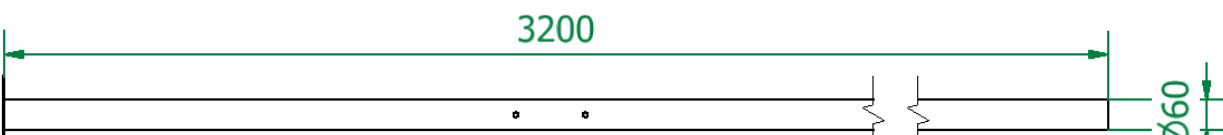
RO-2065	Szt./Pcs	1	
			
RO-PALM	Szt./Pcs	1	
			
SL-565	Szt./Pcs	1	
			
SL-1065	Szt./Pcs	2	
			
SL-1265	Szt./Pcs	7	
			
SL-1400	Szt./Pcs	2	
			
RO-2800	Szt./Pcs	1	
			
RO-3200	Szt./Pcs	1	
			

4. Etapy instalacji Installation steps

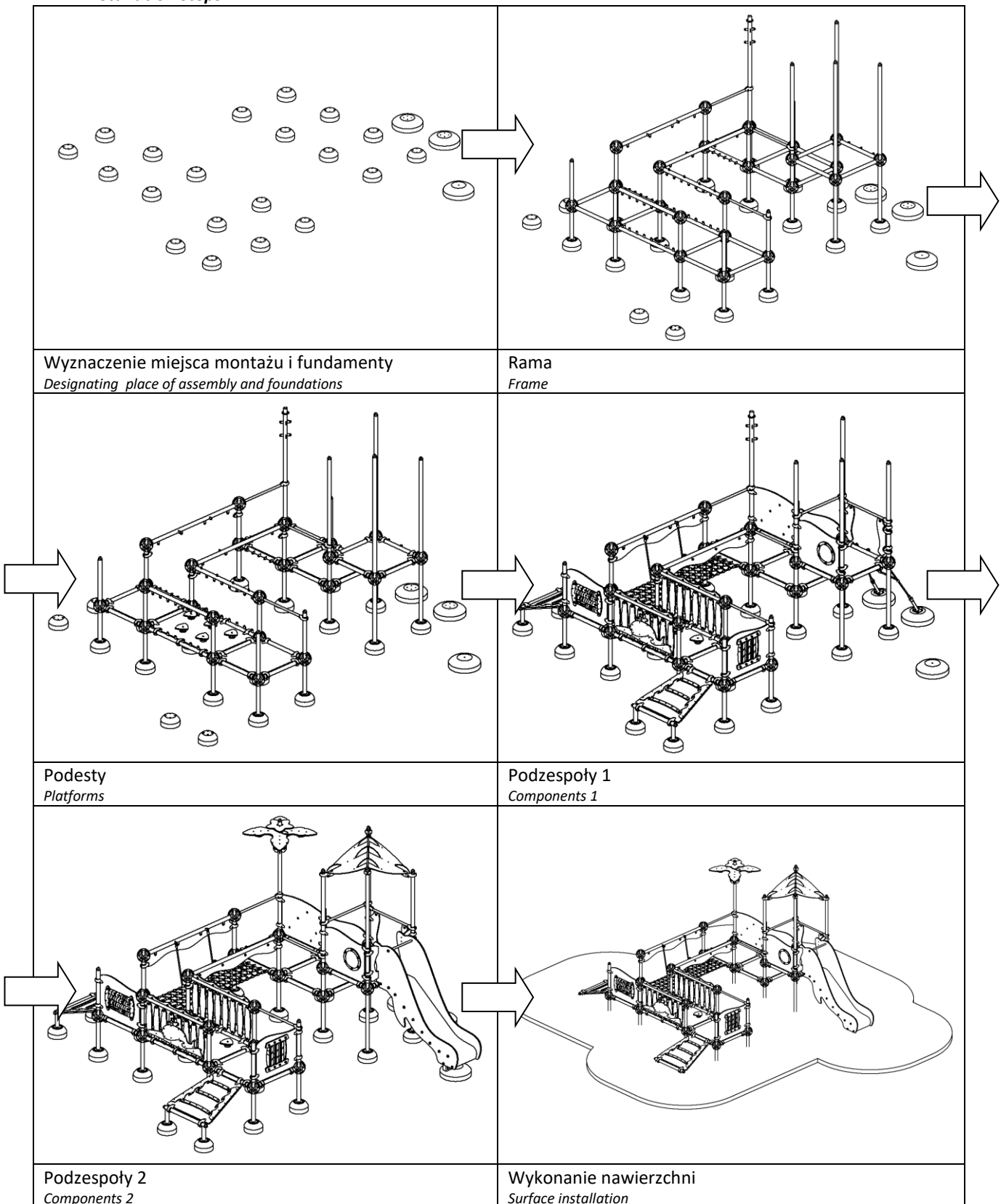

5. Fundamenty i powierzchnia zderzenia

Foundations and impact area

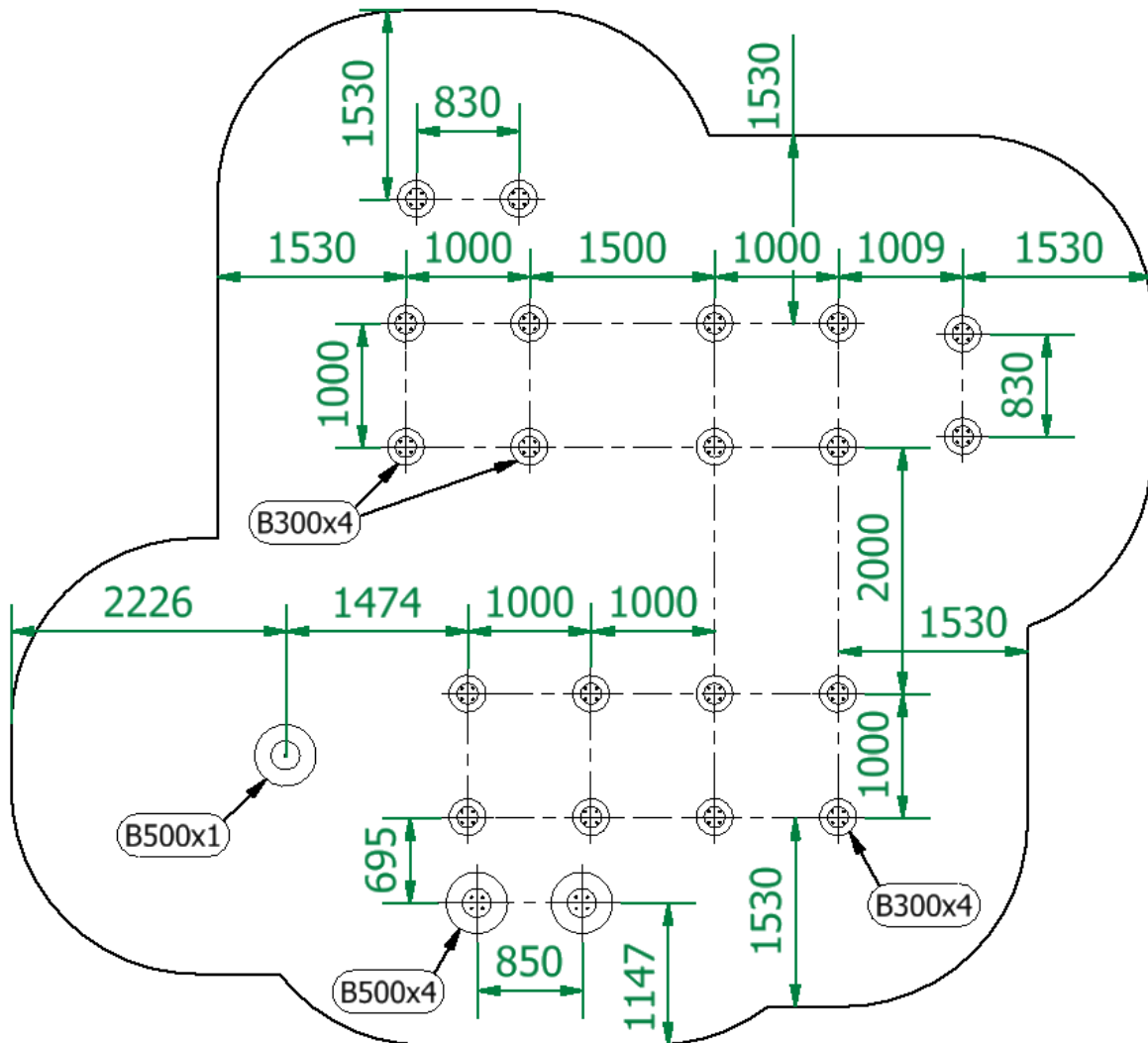

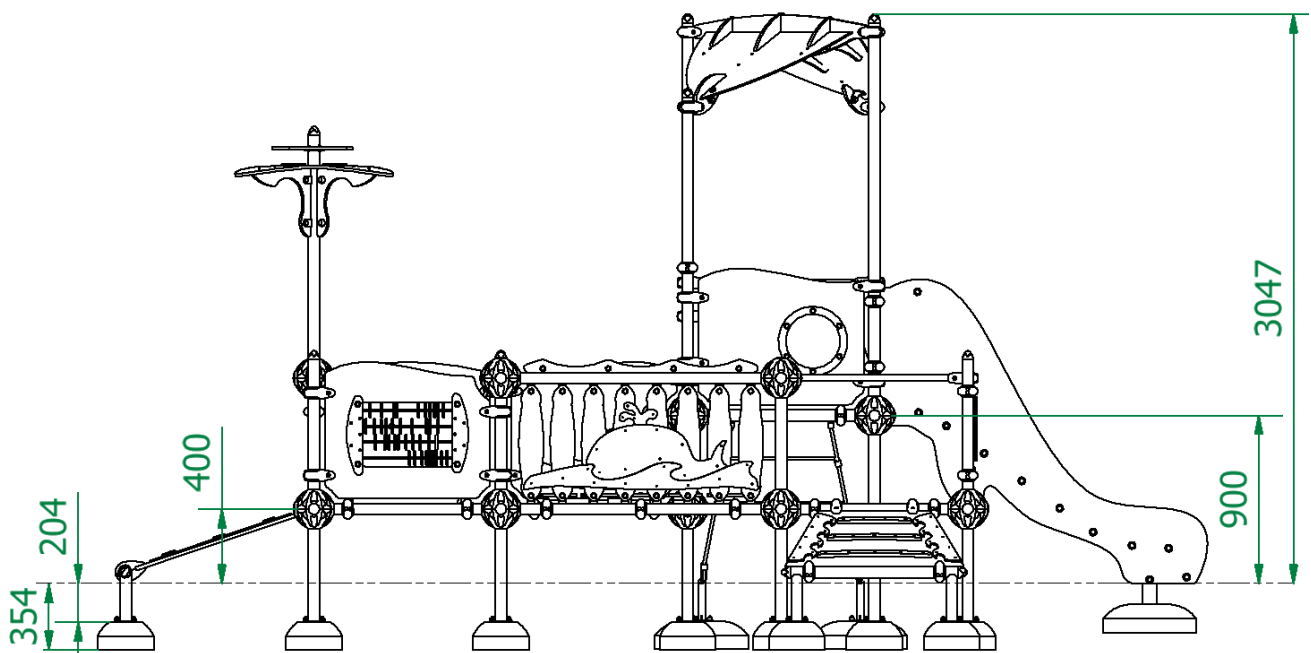
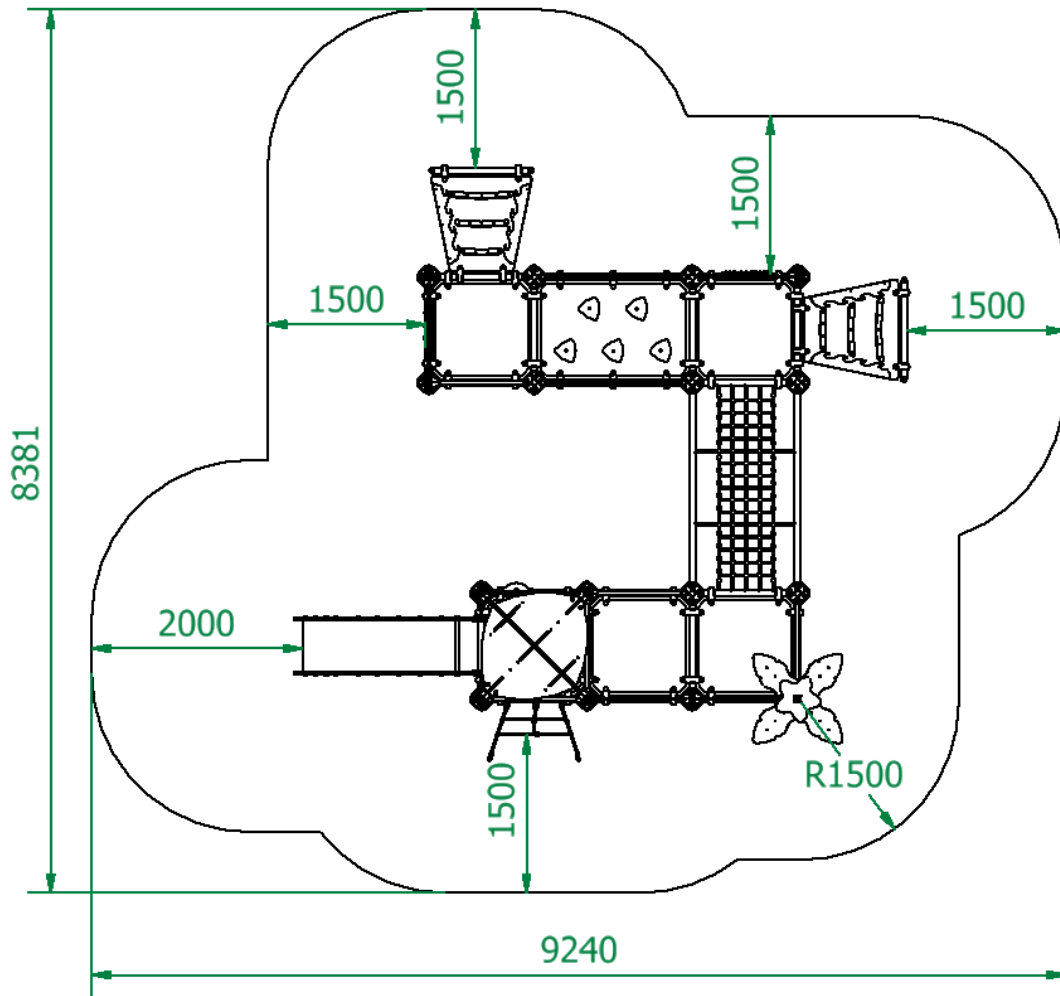

6. Rama
Frame

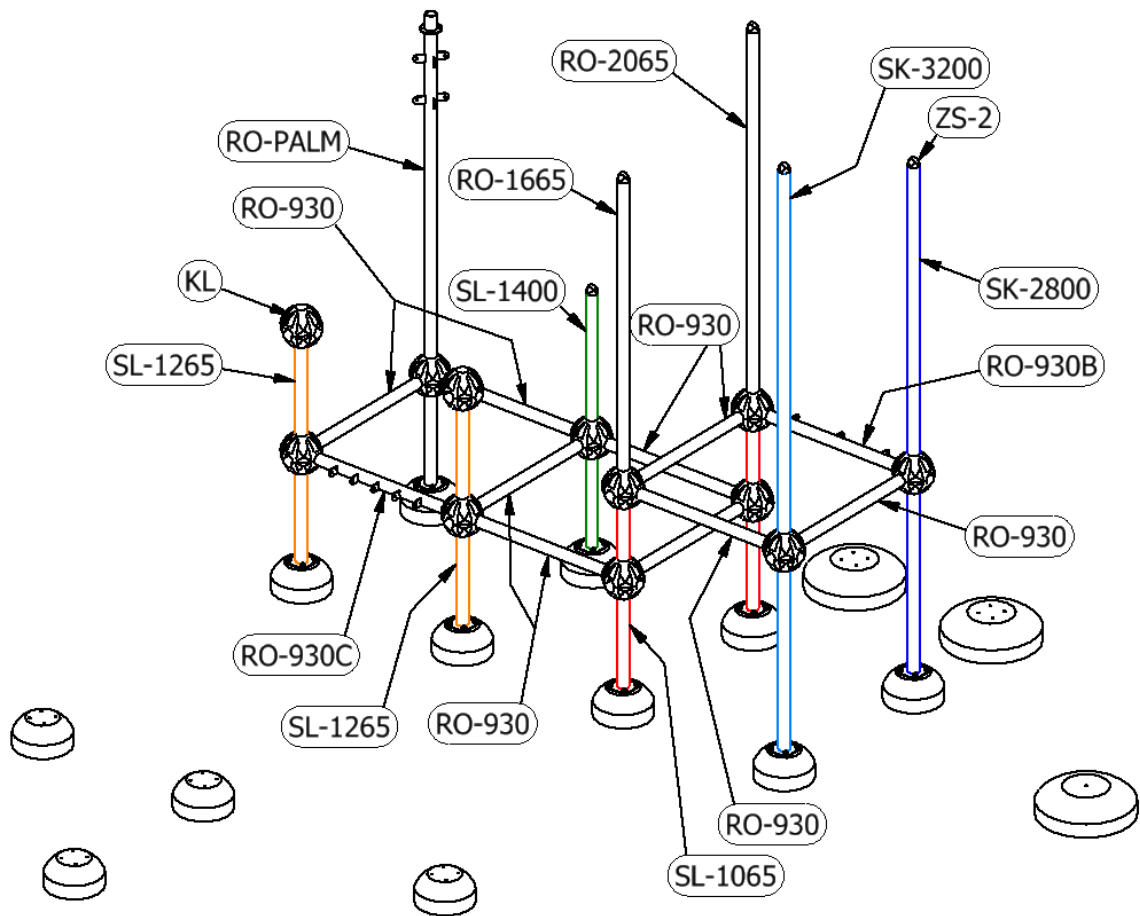

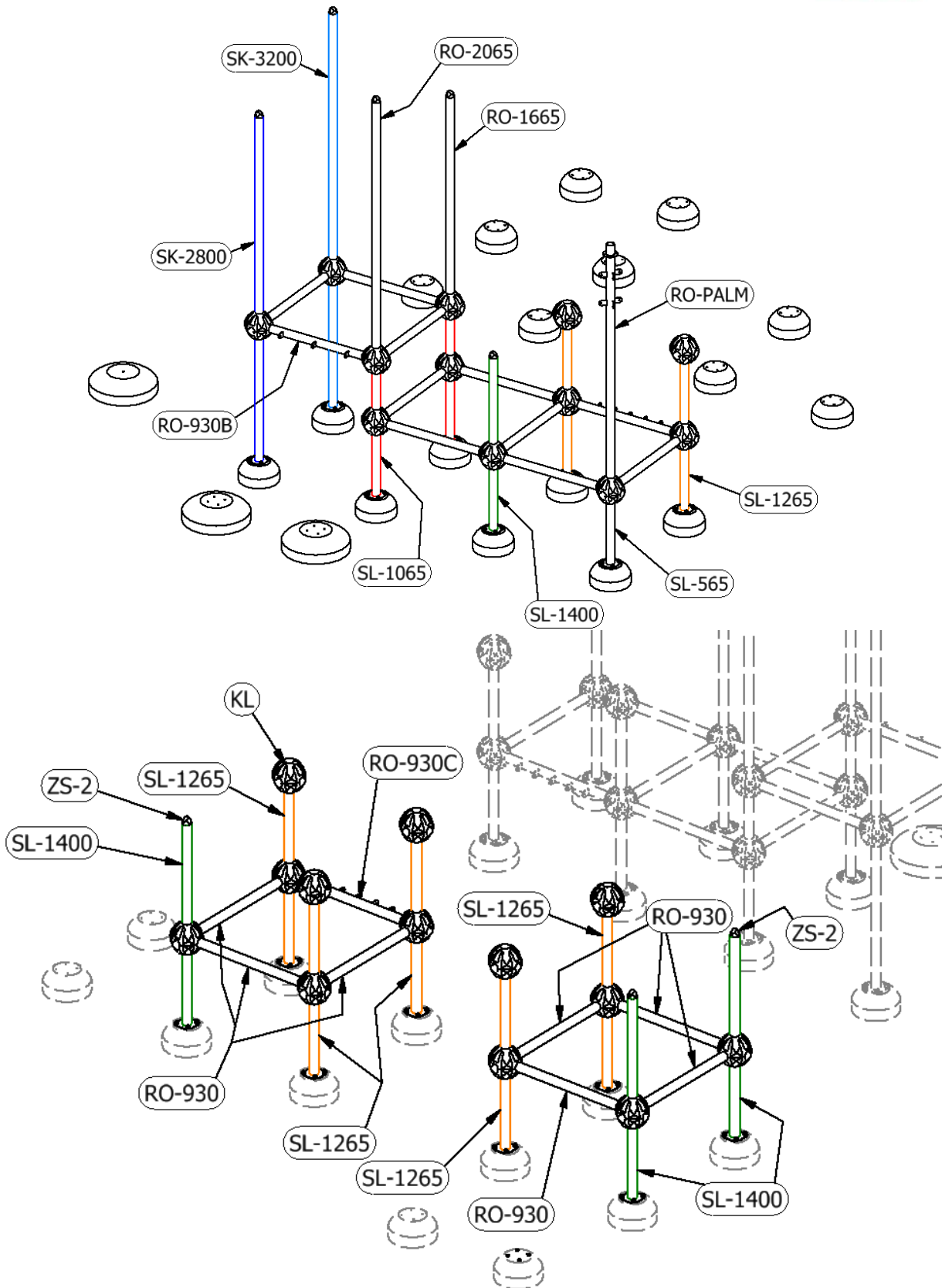

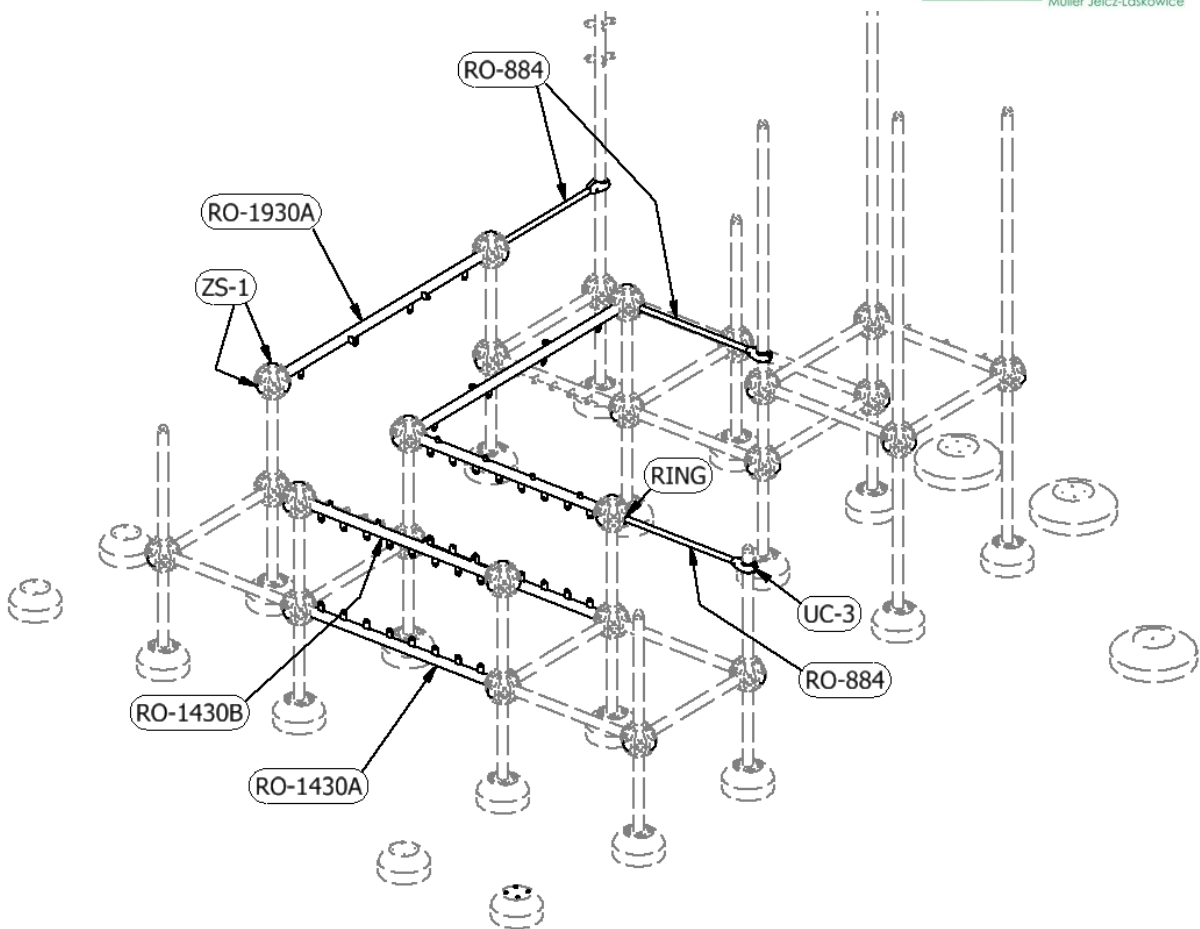

7. Podesty / Platforms

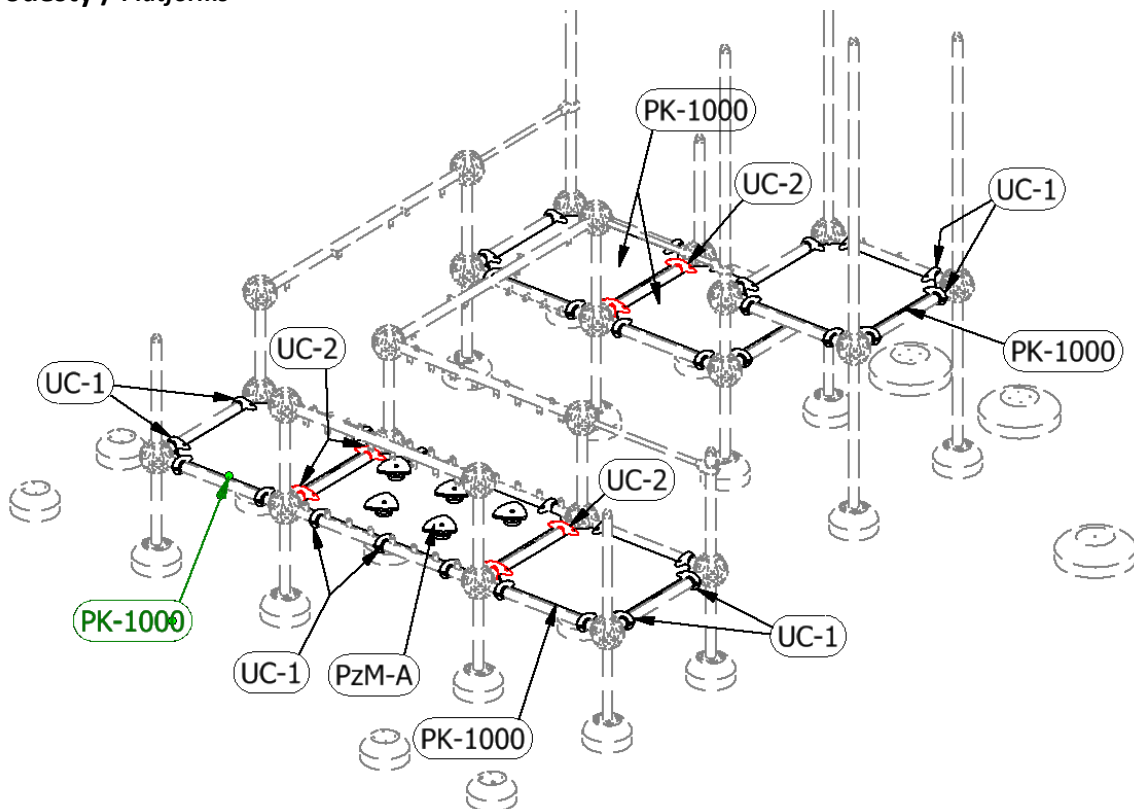

8. Podzespoły / Components

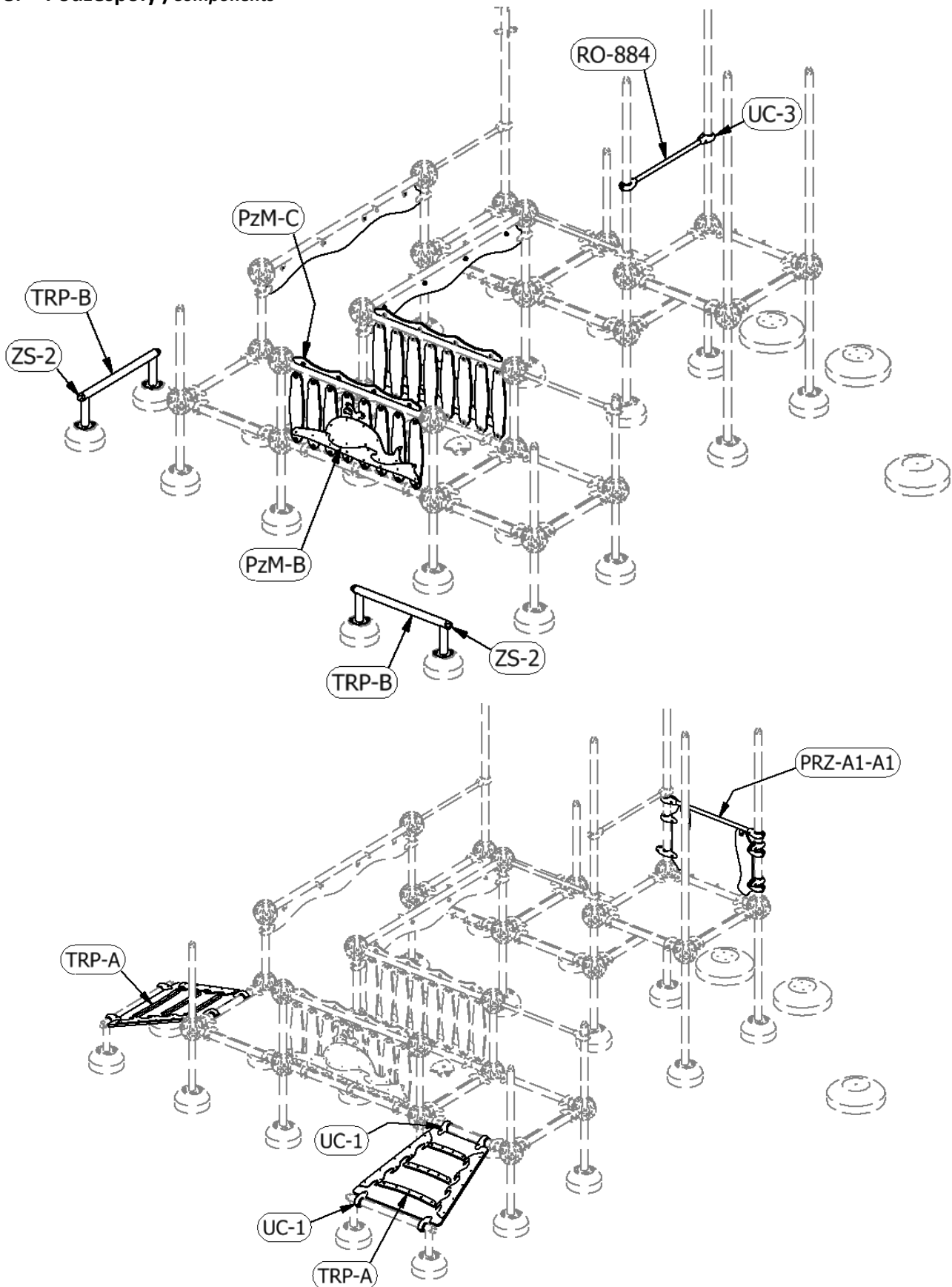

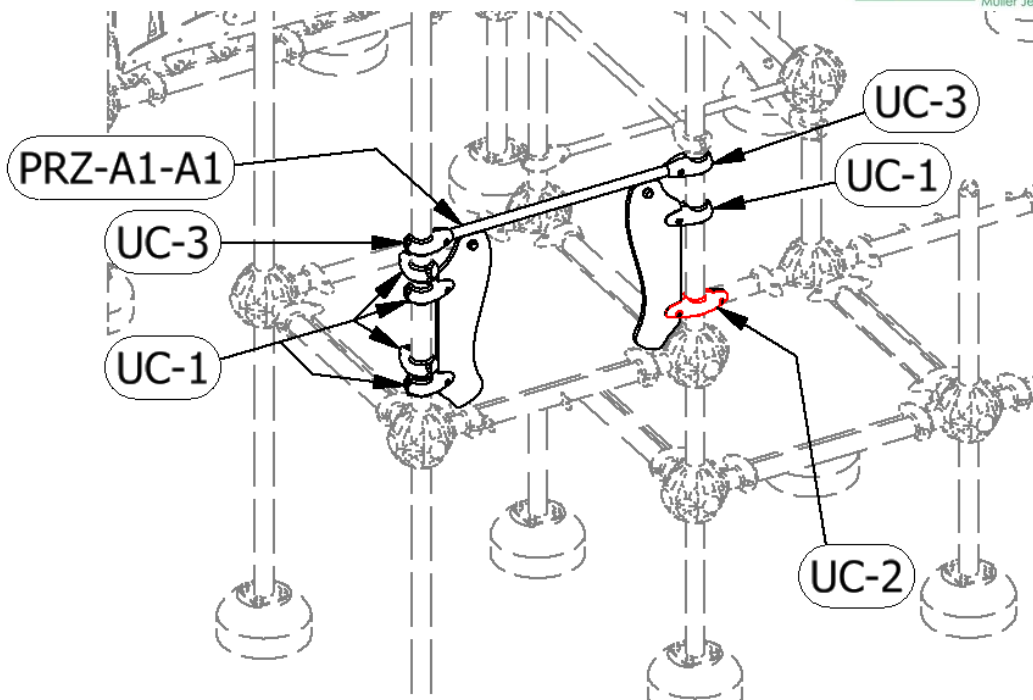

Zalecane wstępne nałożenie uchwytów (bez dokręcania) / Recommended initial assembly of holders (without tightening)

