

INSTRUKCJA MONTAŻU

INSTALLATION INSTRUCTION

Wydanie <i>Edition</i>	01
Data <i>Date</i>	22-05-2018

OCEAN 12

OCEAN 12

Numer katalogowy
catalogue number **820012**













1. Informacje techniczne

Technical information

Grupa wiekowa <i>User age</i>	0-14
Maksymalna wysokość swobodnego upadku <i>Max. free fall height</i>	0,93 m
Największa część <i>Largest part</i>	Zjeżdżalnia <i>Slide</i>
Wymiary największej części <i>Largest part dimensions</i>	2,33 x 1,04 x 0,57 m
Masa największej części <i>Largest part weight</i>	70 kg
Masa największego fundamentu <i>Largest foundation weight</i>	60 kg
Zgodność z normami <i>Accordance with standards</i>	EN 1176-1:2008 EN 1176-3:2008

2. Wykaz narzędzi

Tools list

					
			 x2		

3. Wykaz części

Parts list

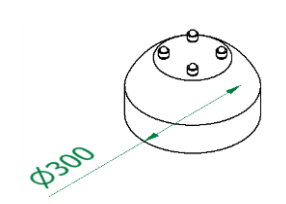
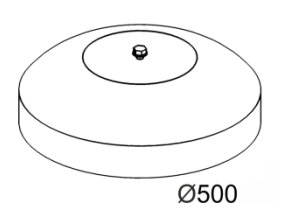
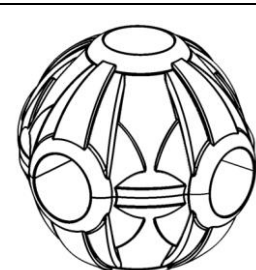
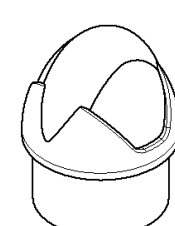
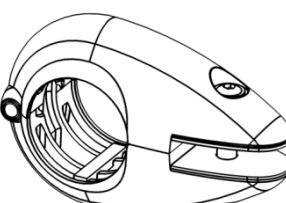
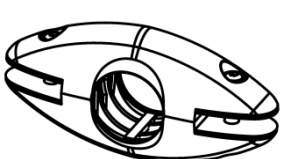
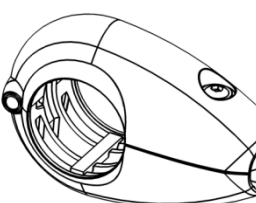
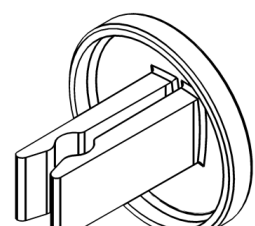
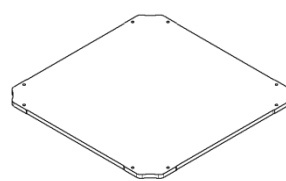
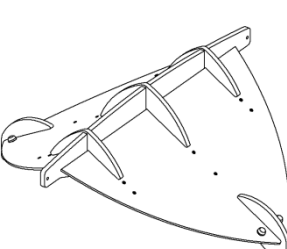
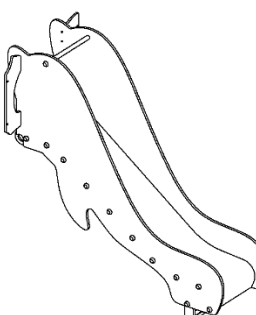
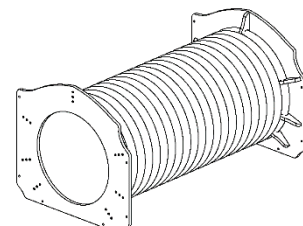
			
B2	B3	KL*	ZS-2
Szt. Pcs 26	Szt. Pcs 1	Szt. Pcs 28	Szt. Pcs 12
			
UC-1*	UC-2*	UC-3*	ZS-1*
Szt. Pcs 96	Szt. Pcs 7	Szt. Pcs 2	Szt. Pcs 72
			
PK-1000*	D2	ZI*	TUN
Szt. Pcs 5	Szt. Pcs 1	Szt. Pcs 1	Szt. Pcs 1

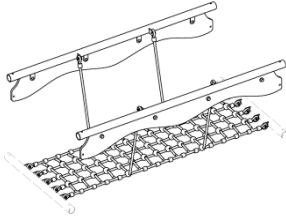
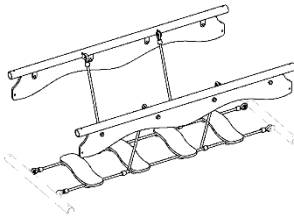
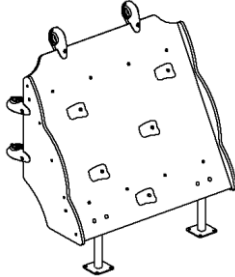
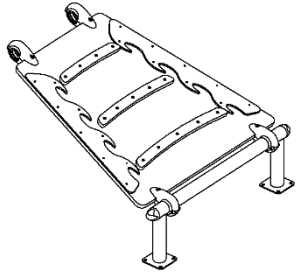
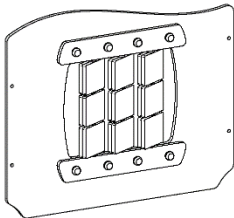
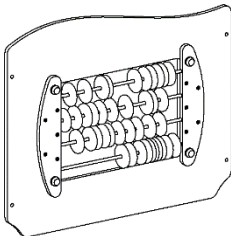
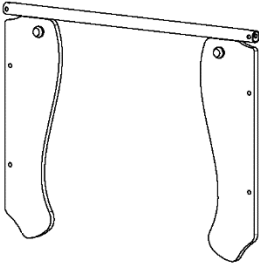
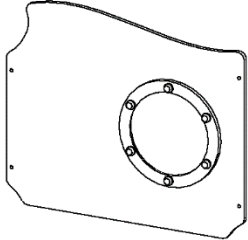
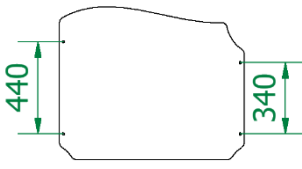
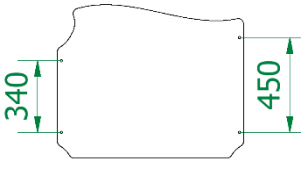
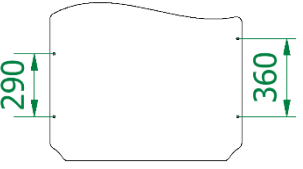
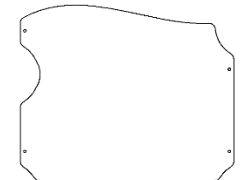
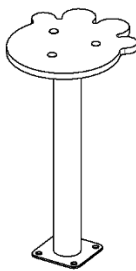
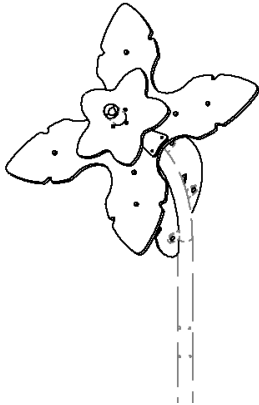
											
ML	Szt. Pcs	1	MKL	Szt. Pcs	1	WW	Szt. Pcs	1	TRP	Szt. Pcs	1
											
XO	Szt. Pcs	1	LIC	Szt. Pcs	1	PRZ-1	Szt. Pcs	1	BAR-BUL	Szt. Pcs	1
											
BAR-D1	Szt. Pcs	1	BAR-C1	Szt. Pcs	1	BAR-A2	Szt. Pcs	1	BAR-E1	Szt. Pcs	1
											
LAP	Szt. Pcs	4	PALM	Szt. Pcs	2						

* patrz – instrukcja szczegółowa
see – detailed instruction

Rury
pipes

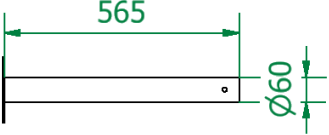
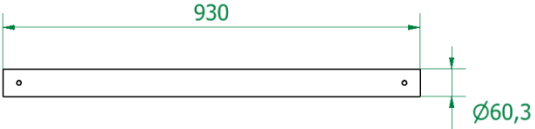
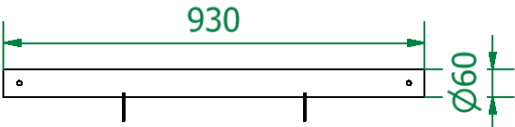
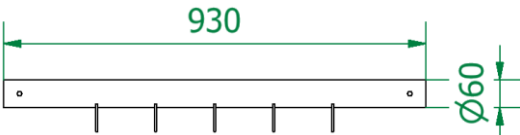
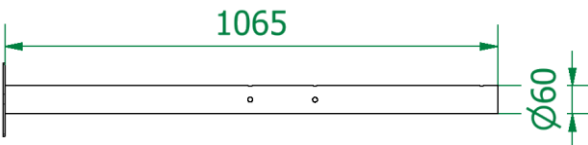
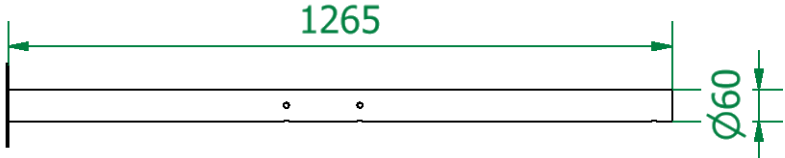
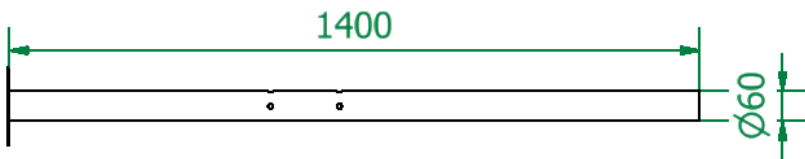
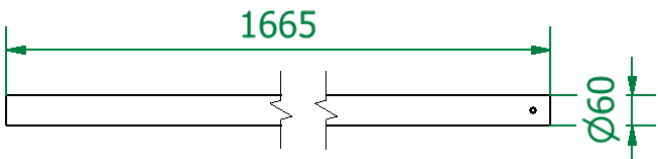
RO-1	Szt./Pcs	1
		
RO-2	Szt./Pcs	16
		
RO-3	Szt./Pcs	2
		
RO-4	Szt./Pcs	2
		
RO-5	Szt./Pcs	2
		
RO-6	Szt./Pcs	8
		
RO-7	Szt./Pcs	4
		
RO-8	Szt./Pcs	1
		

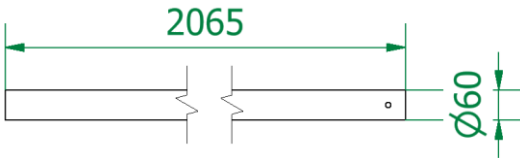
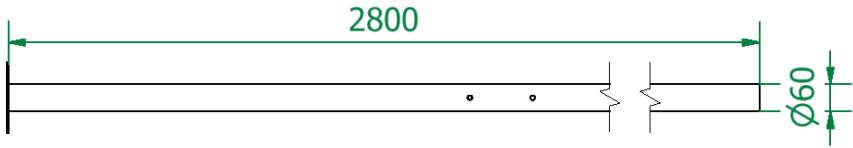
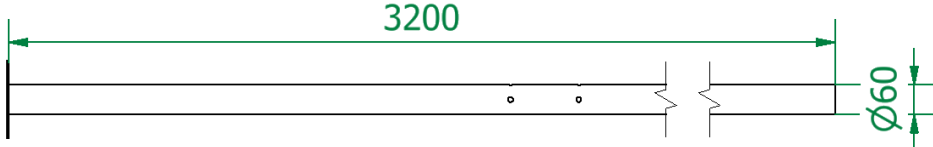
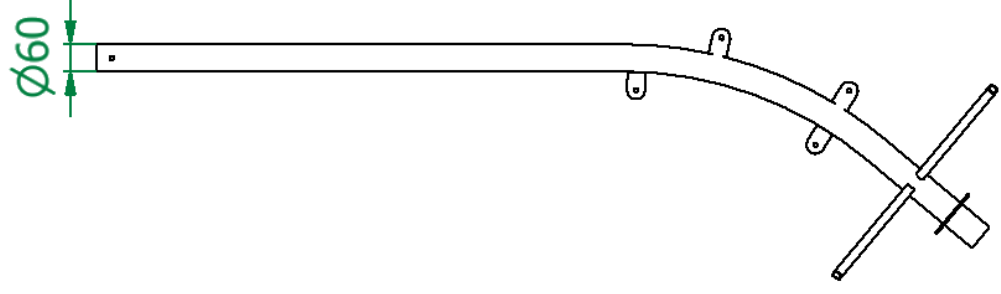
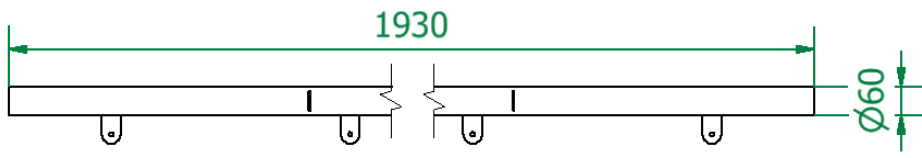
Code	Szt./Pcs	Quantity	
RO-9	Szt./Pcs	1	
RO-10	Szt./Pcs	1	
RO-11	Szt./Pcs	1	
RO-PALM	Szt./Pcs	2	
RO-ML	Szt./Pcs	4	

4. Etapy instalacji Installation steps

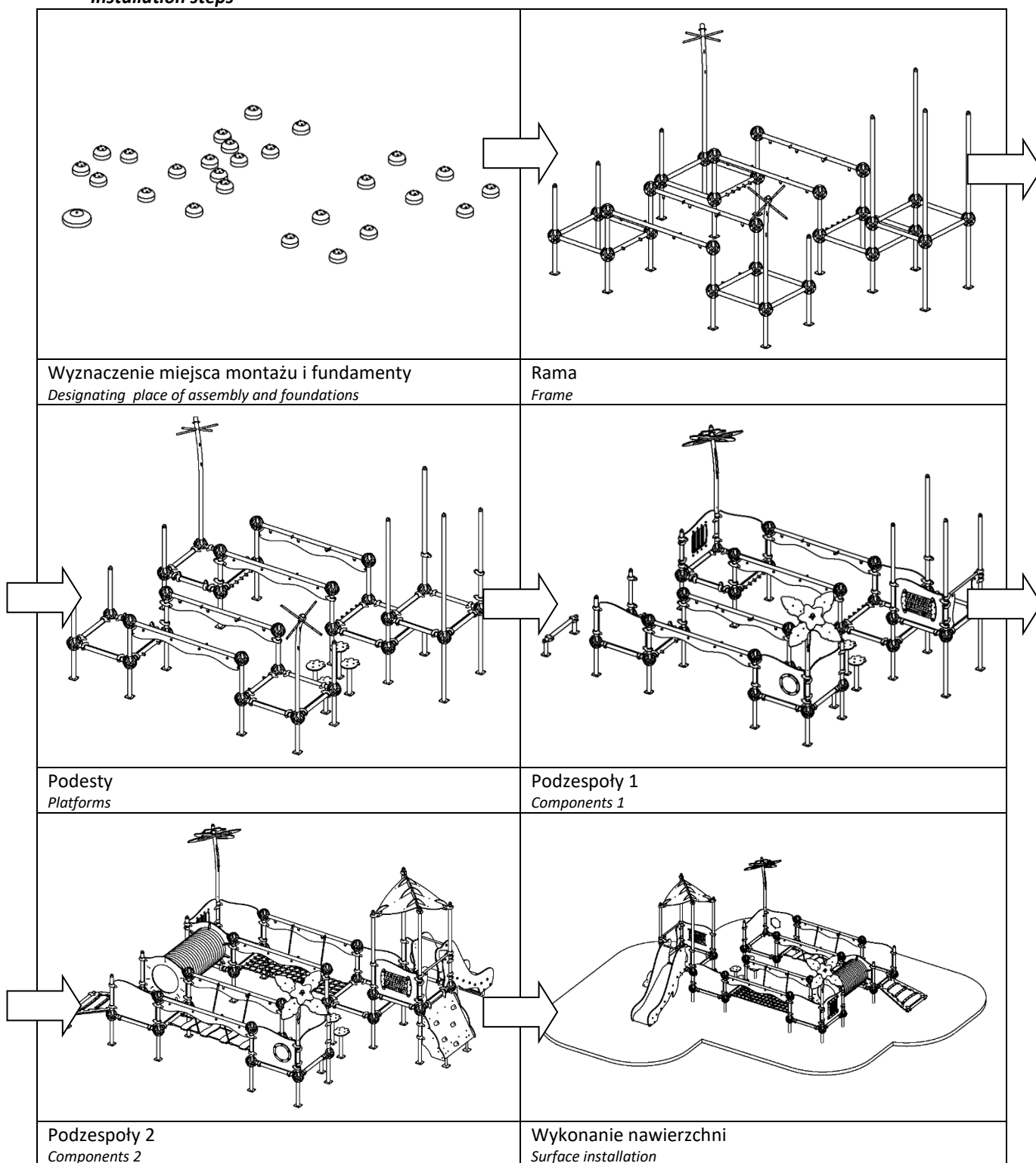

5. Fundamenty i powierzchnia zderzenia

Foundations and impact area

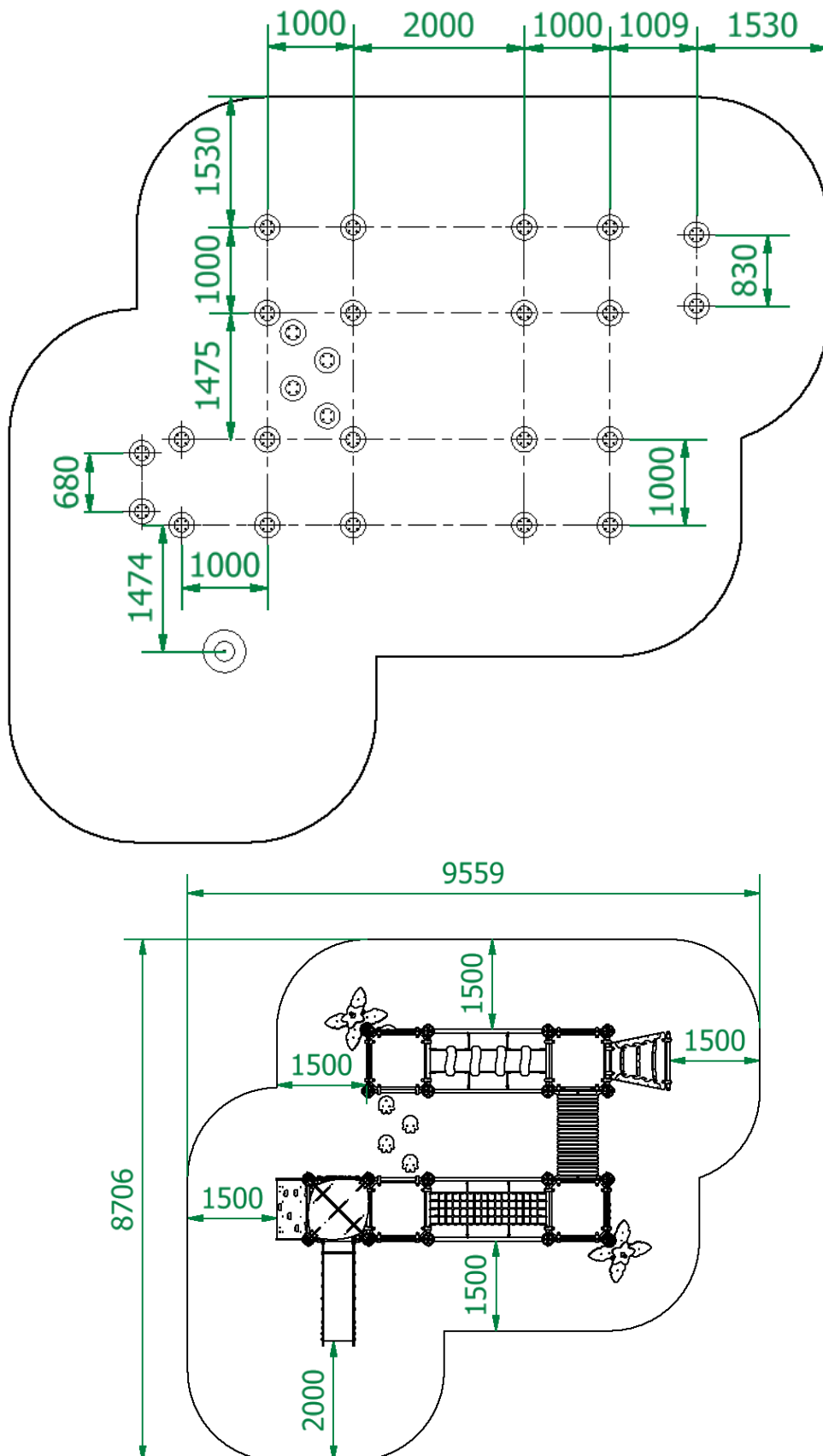

6. Rama Frame

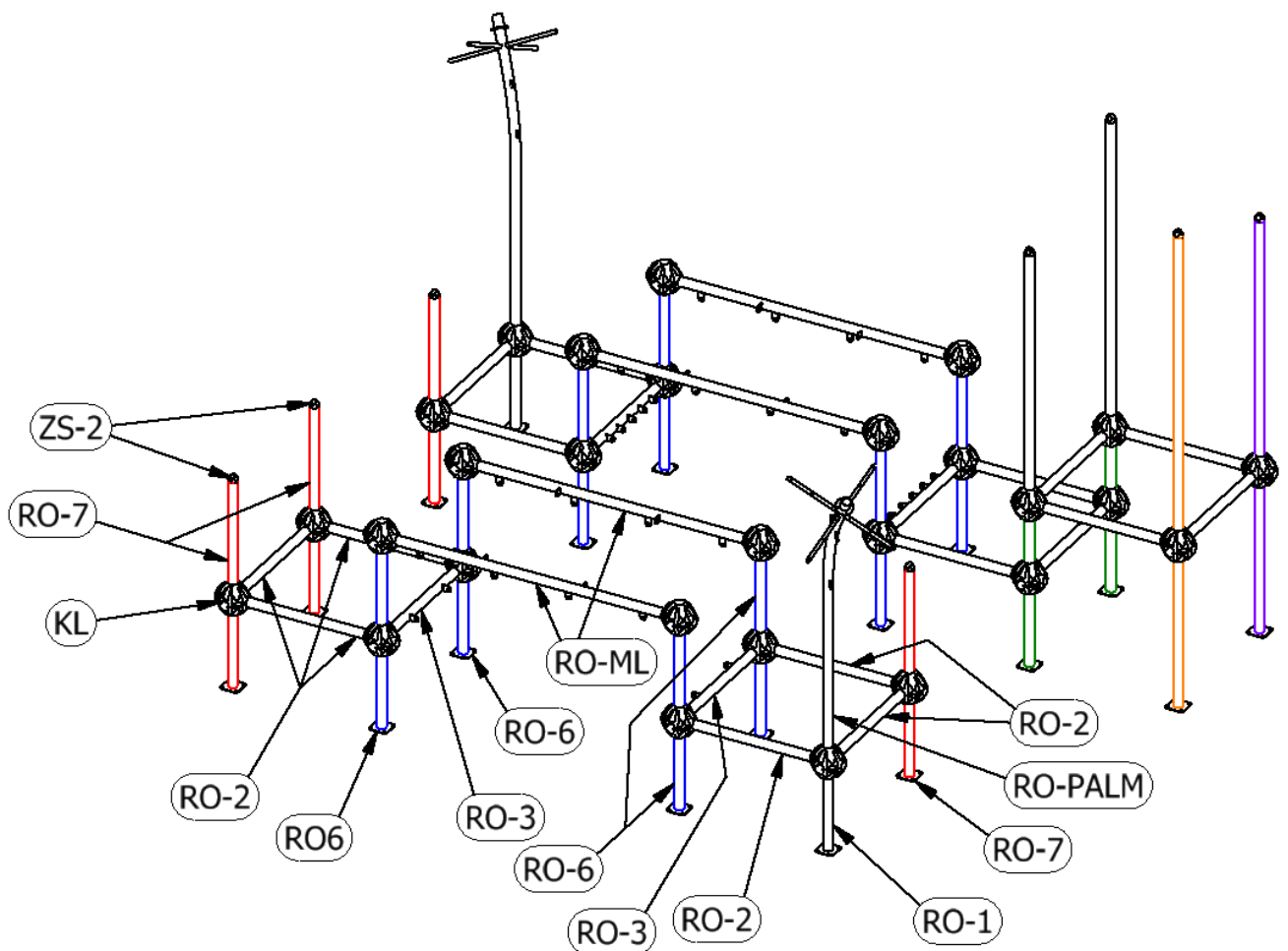
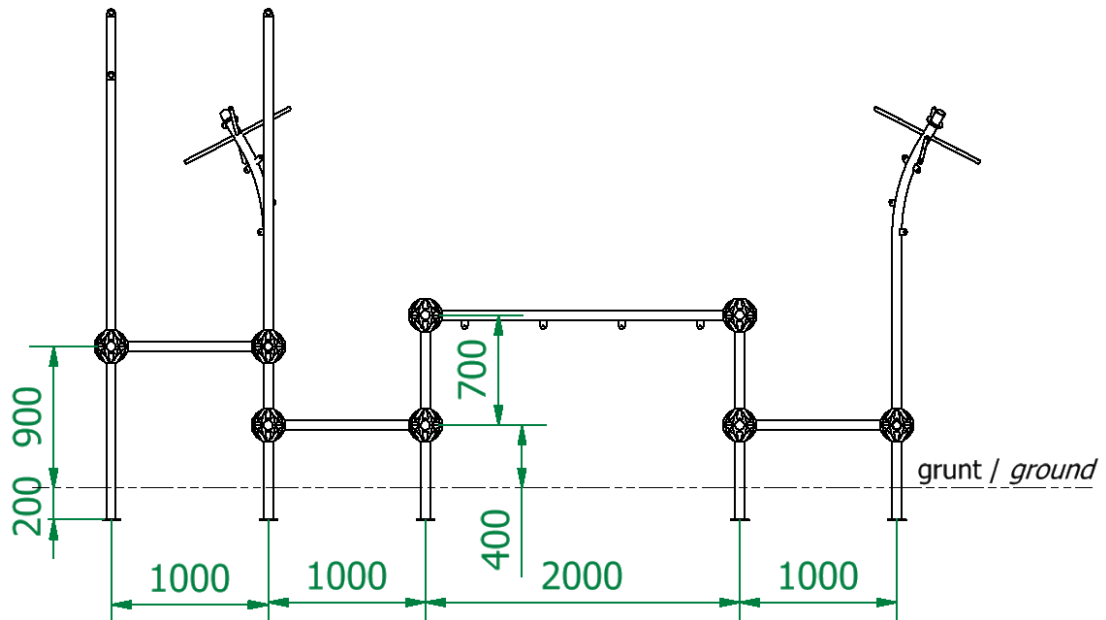

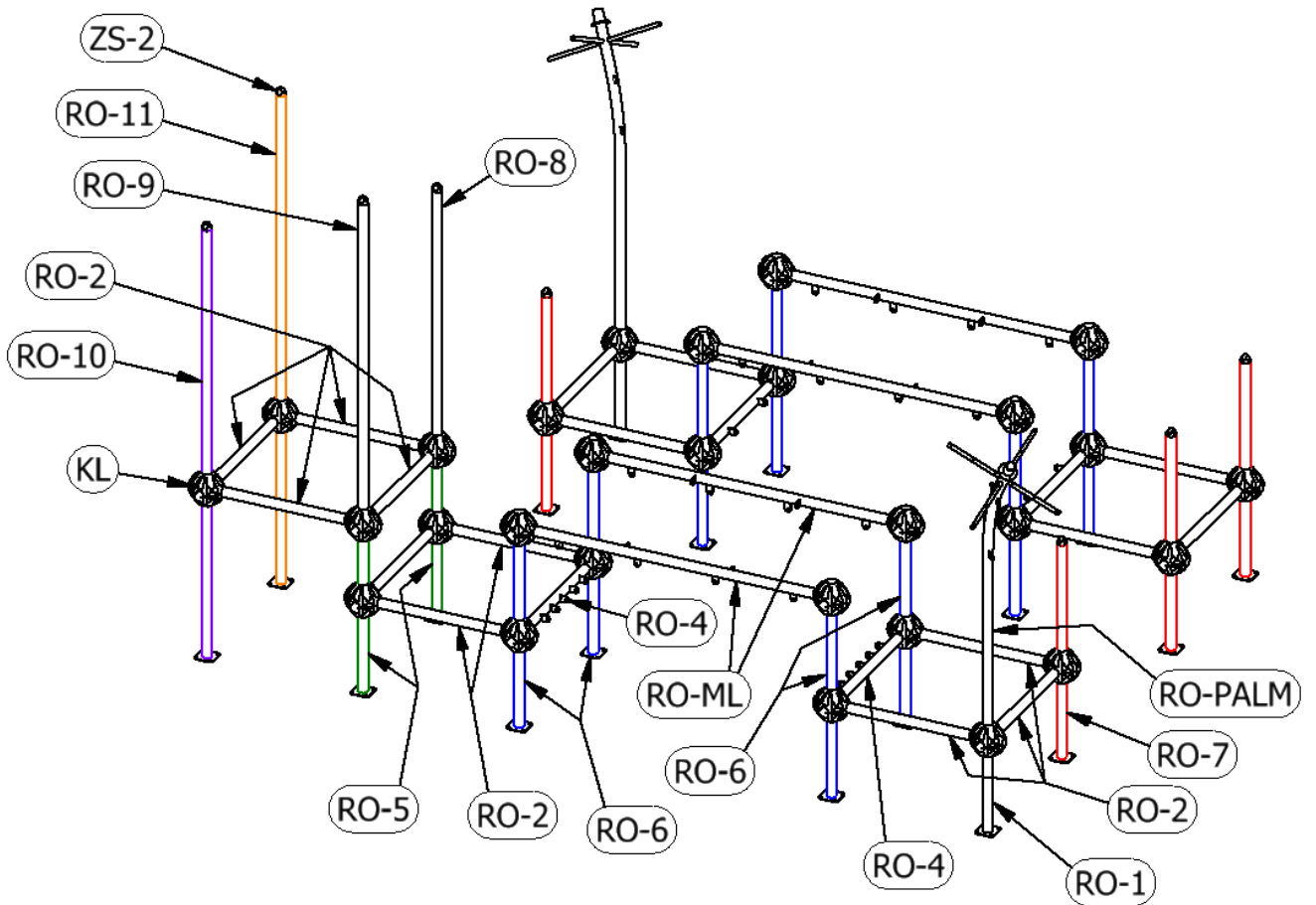

7. Podesty Platforms

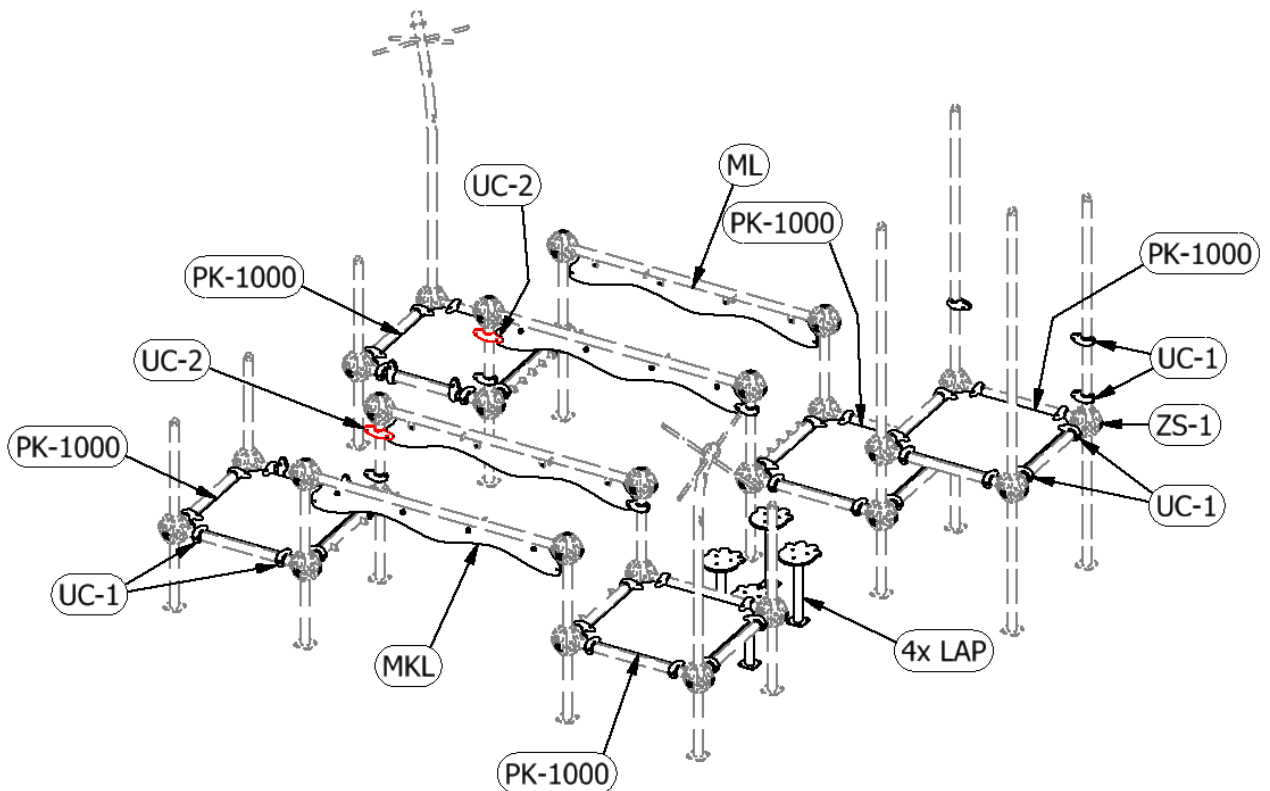

Zalecane wstępne nałożenie uchwytów (bez dokręcania)
Recommended initial asseby of holders (without tightening)

8. Podzespoły *Components*

