

INSTRUKCJA MONTAŻU

INSTALLATION INSTRUCTION

Wydanie <i>Edition</i>	01
Data <i>Date</i>	01-09-2015

ZAMEK 2

CASTLE 2

Numer katalogowy
catalogue number **83002**

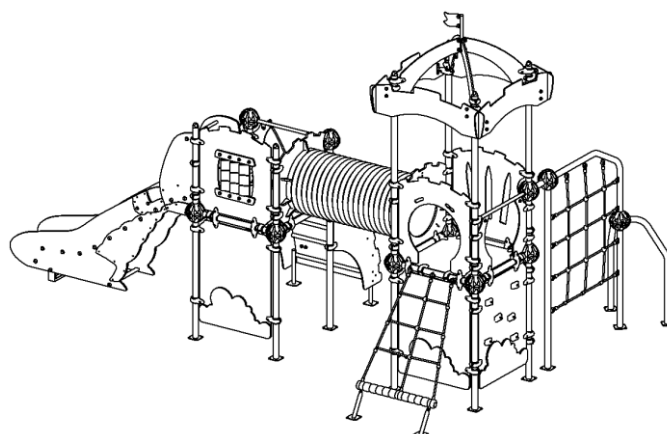









1. Informacje techniczne

Technical information

Grupa wiekowa <i>User age</i>	6-14
Maksymalna wysokość swobodnego upadku <i>Max. free fall height</i>	1,9 m
Największa część <i>Largest part</i>	Zjeżdżalnia <i>Slide</i>
Wymiary największej części <i>Largest part dimensions</i>	2,1 x 2,5 x 0,6 m
Masa największej części <i>Largest part weight</i>	90 kg
Masa największego fundamentu <i>Largest foundation weight</i>	60 kg
Zgodność z normami <i>Accordance with standards</i>	EN 1176-1:2008 EN 1176-3:2008

2. Wykaz narzędzi

Tools list

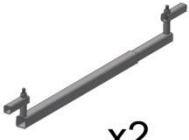
					
			 x2		

3. Wykaz części

Parts list

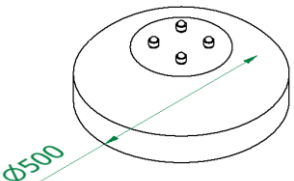
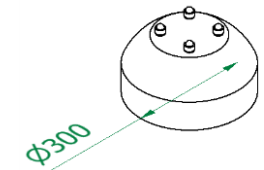
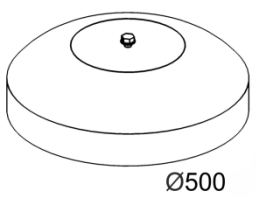
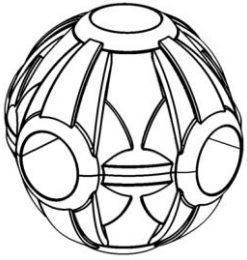
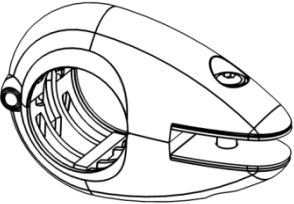
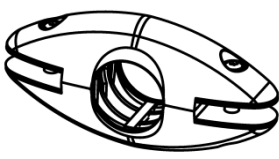
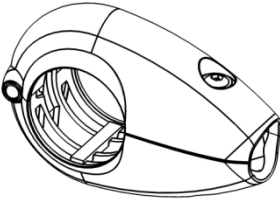
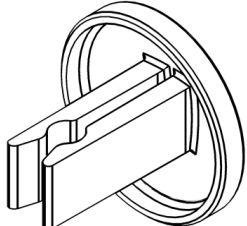
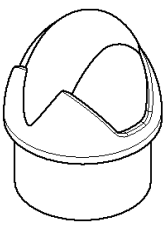
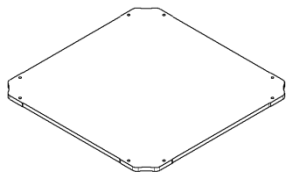
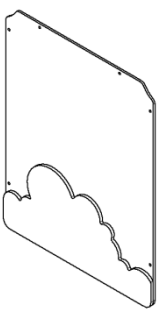
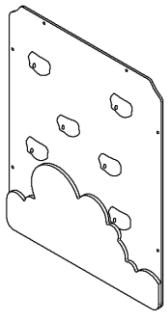
 Ø500	 Ø300	 Ø500					
B1	Szt. Pcs 2	B2	Szt. Pcs 14	B3	Szt. Pcs 1	KL*	Szt. Pcs 13
							
UC-1*	Szt. Pcs 84	UC-2*	Szt. Pcs 8	UC-3*	Szt. Pcs 9	ZS-1*	Szt. Pcs 29
							
ZS-2	Szt. Pcs 6	PK-1000*	Szt. Pcs 2	PLT-1	Szt. Pcs 3	PLT-W	Szt. Pcs 1

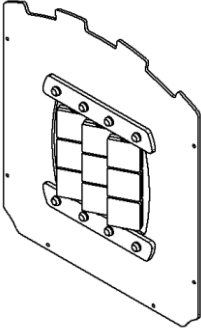
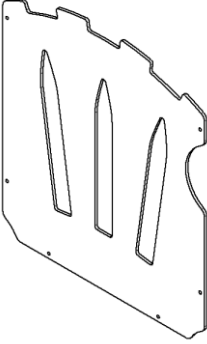
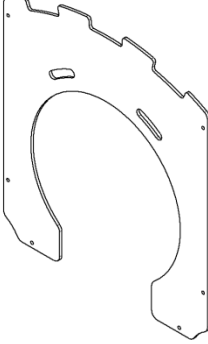
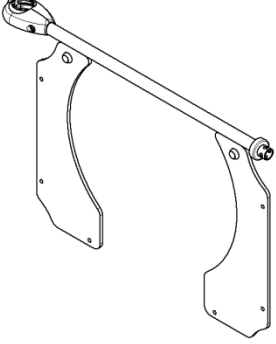
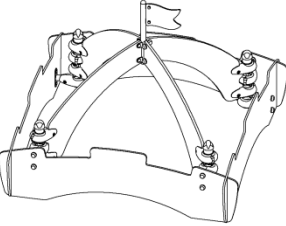
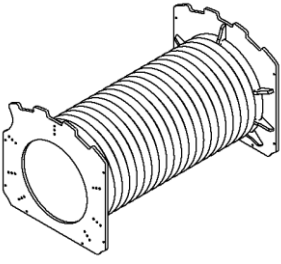
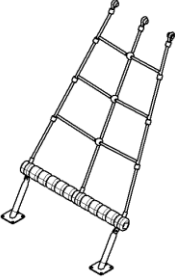
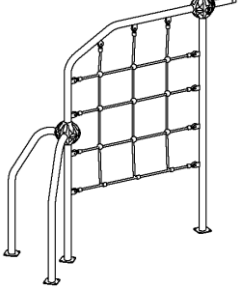
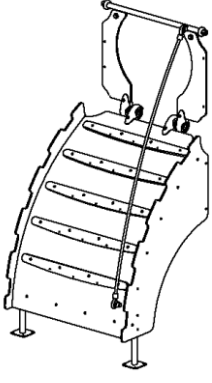
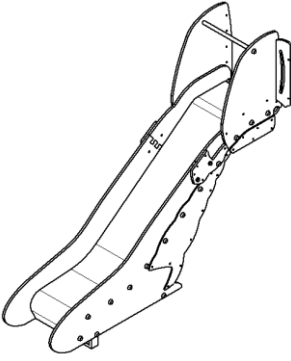
											
XO	Szt. Pcs	1	BAR-1	Szt. Pcs	1	BAR-2	Szt. Pcs	1	OS-1	Szt. Pcs	1
											
D4	Szt. Pcs	1	TUN	Szt. Pcs	1	WL	Szt. Pcs	1	SL	Szt. Pcs	1
											
KG	Szt. Pcs	1	ZJ	Szt. Pcs	1						

* patrz – instrukcja szczegółowa
see – detailed instruction

Rury
pipes

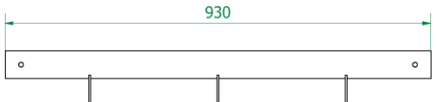
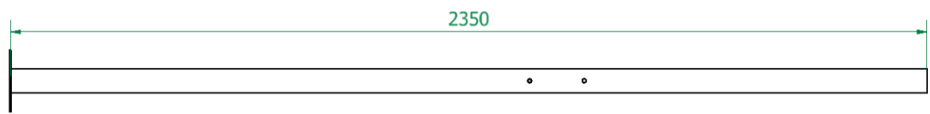
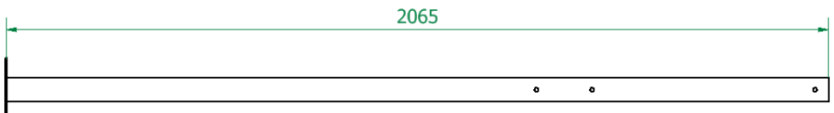
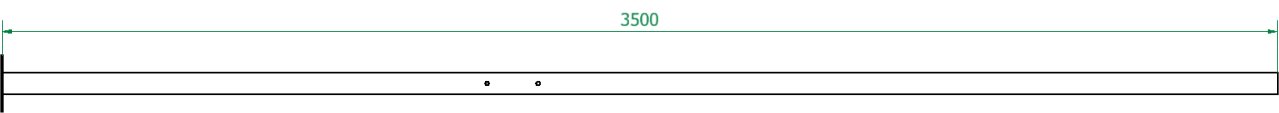
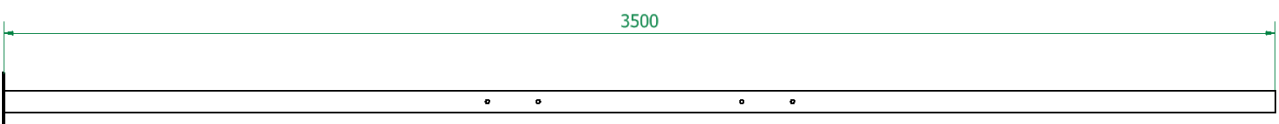
RO-1	Szt./Pcs	7	
			
RO-2	Szt./Pcs	1	
			
RO-3	Szt./Pcs	2	
			
RO-4	Szt./Pcs	2	
			
RO-5	Szt./Pcs	3	
			
RO-6	Szt./Pcs	1	
			

4. Etapy instalacji Installation steps

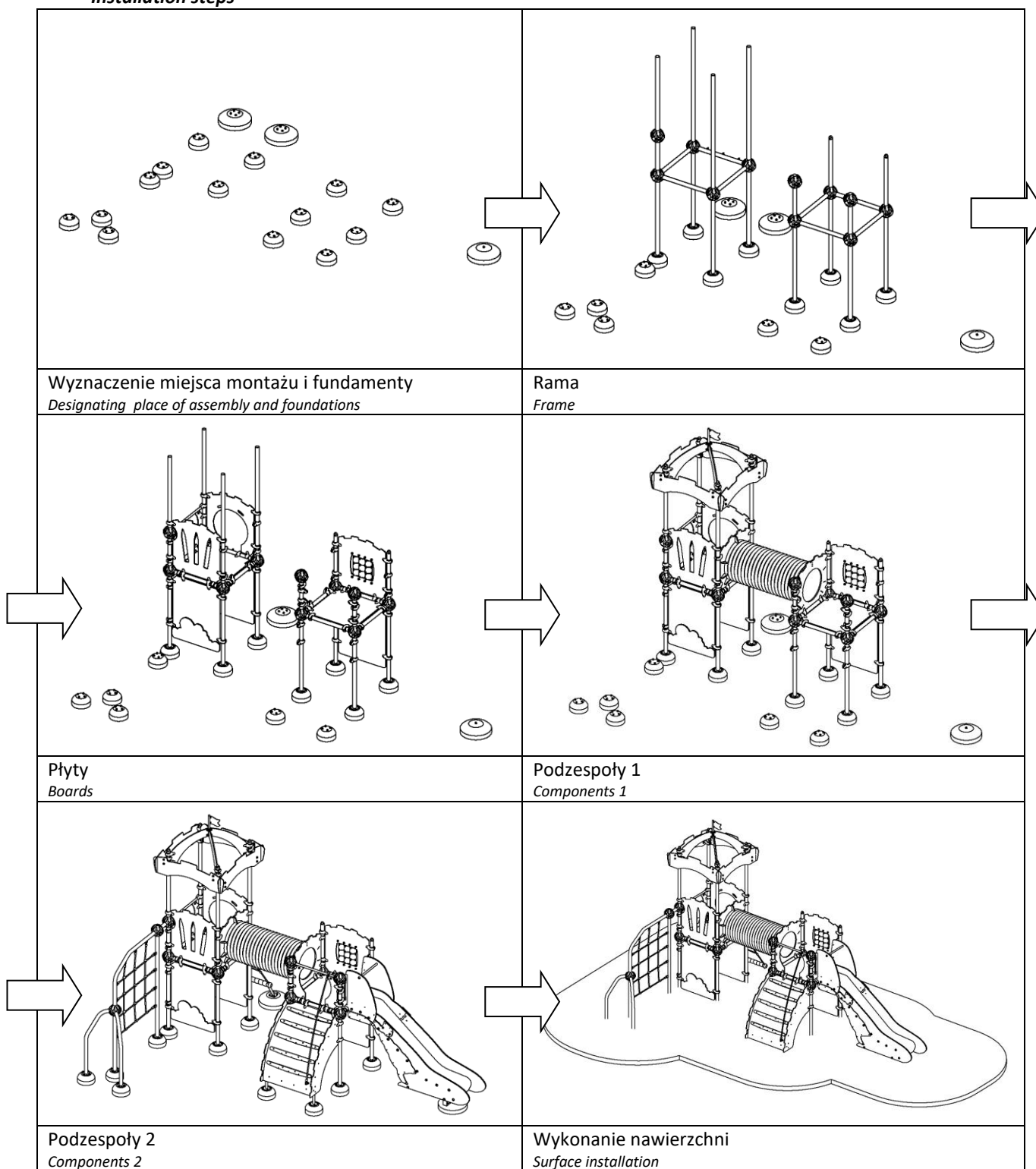

5. Fundamenty i powierzchnia zderzenia

Foundations and impact area

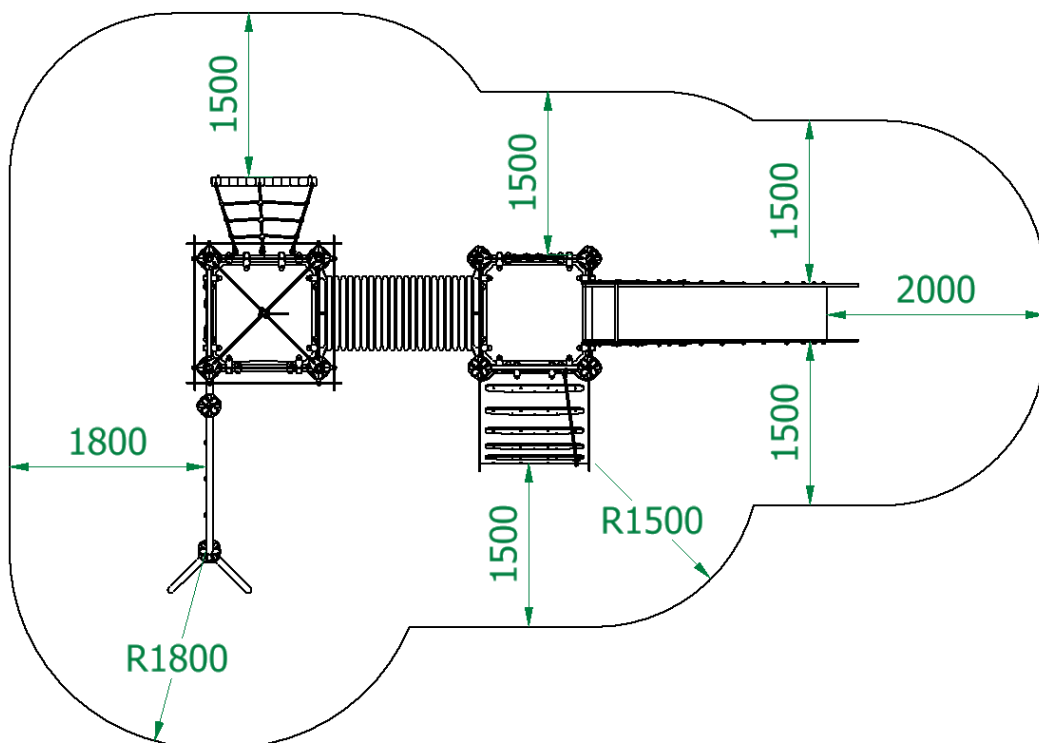
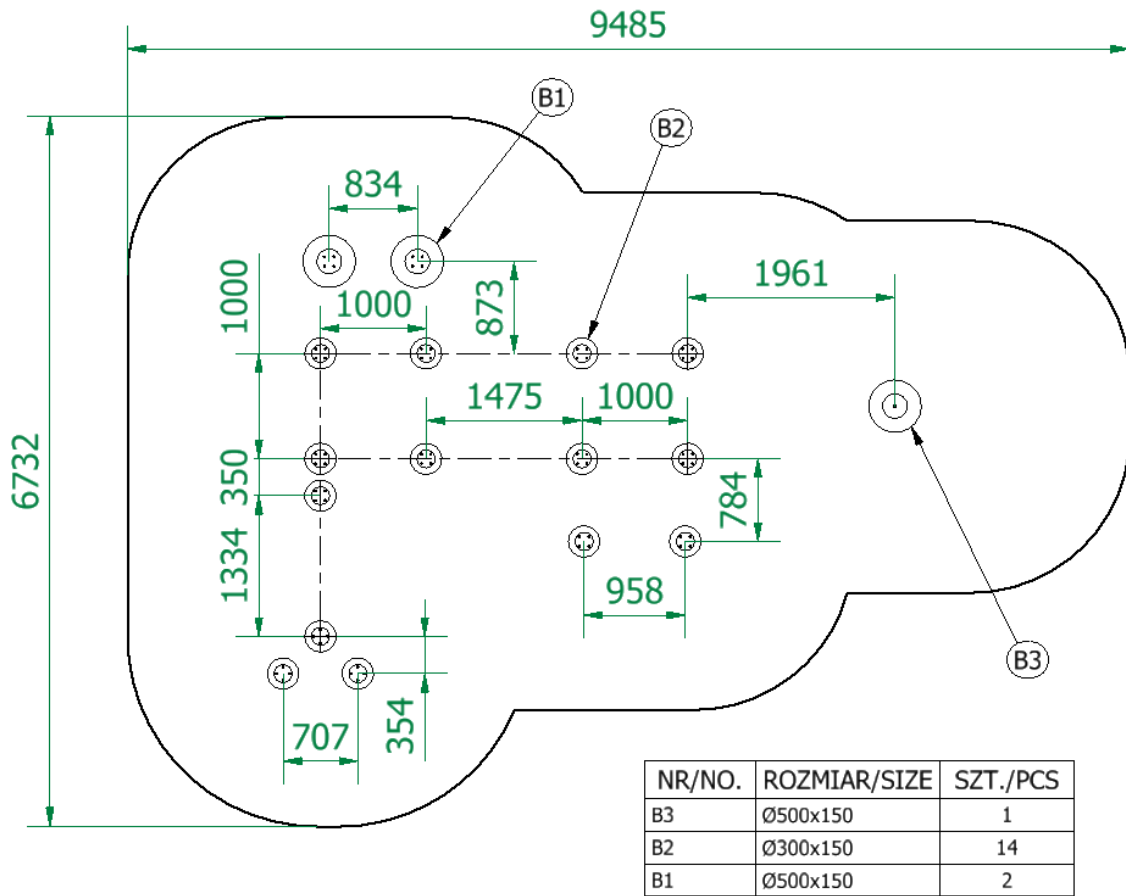

6. Rama Frame

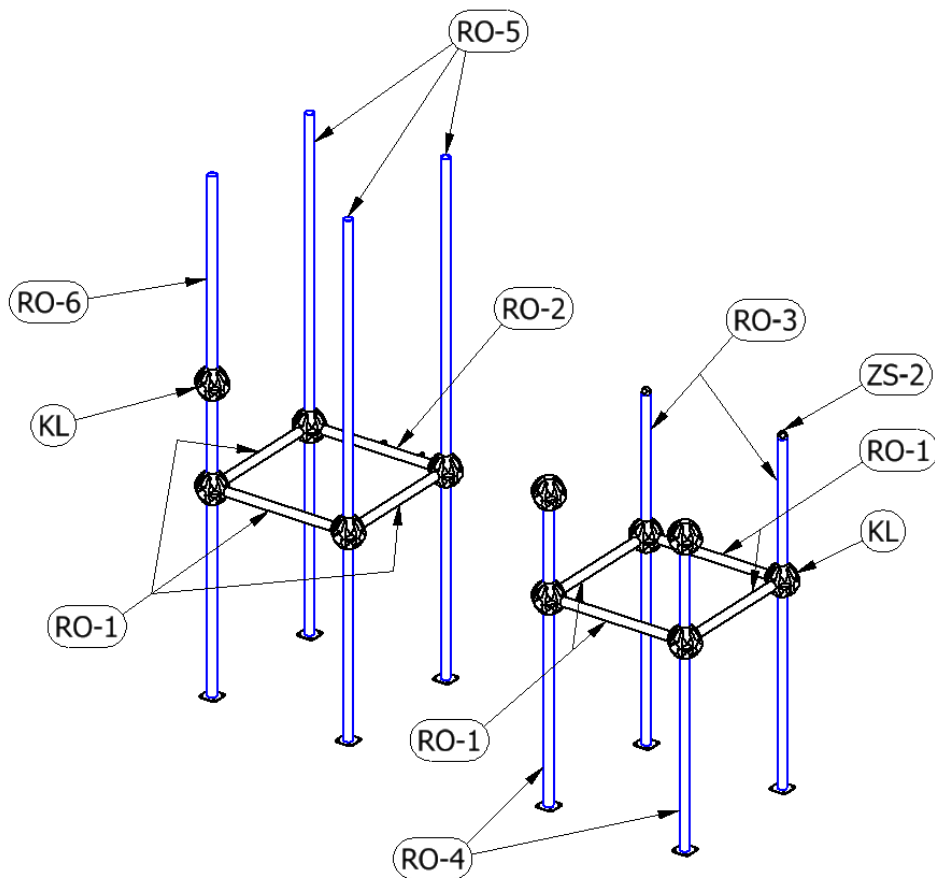
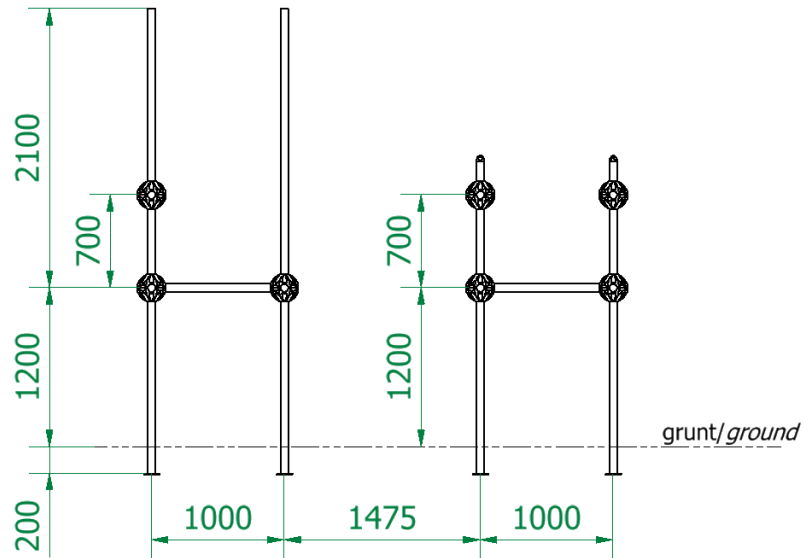

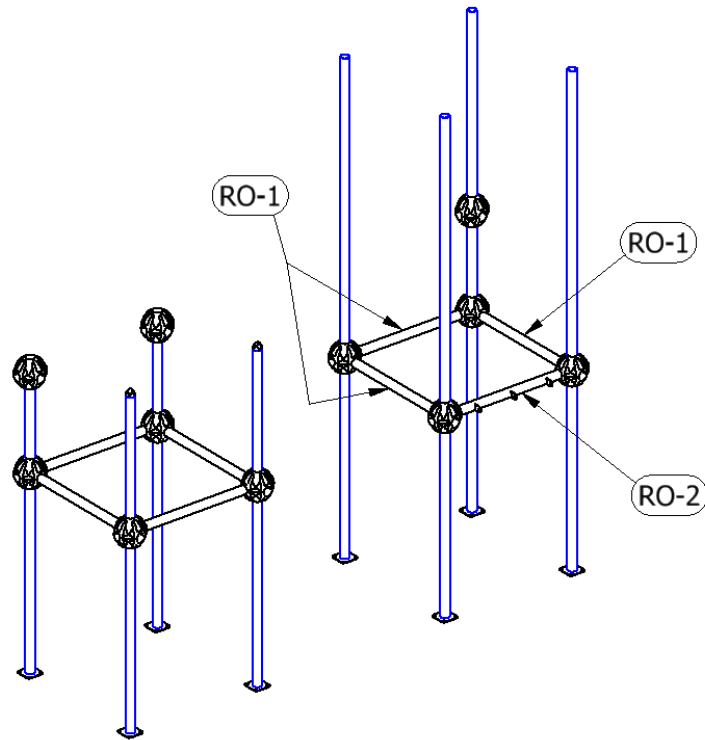

7. Płyty Boards

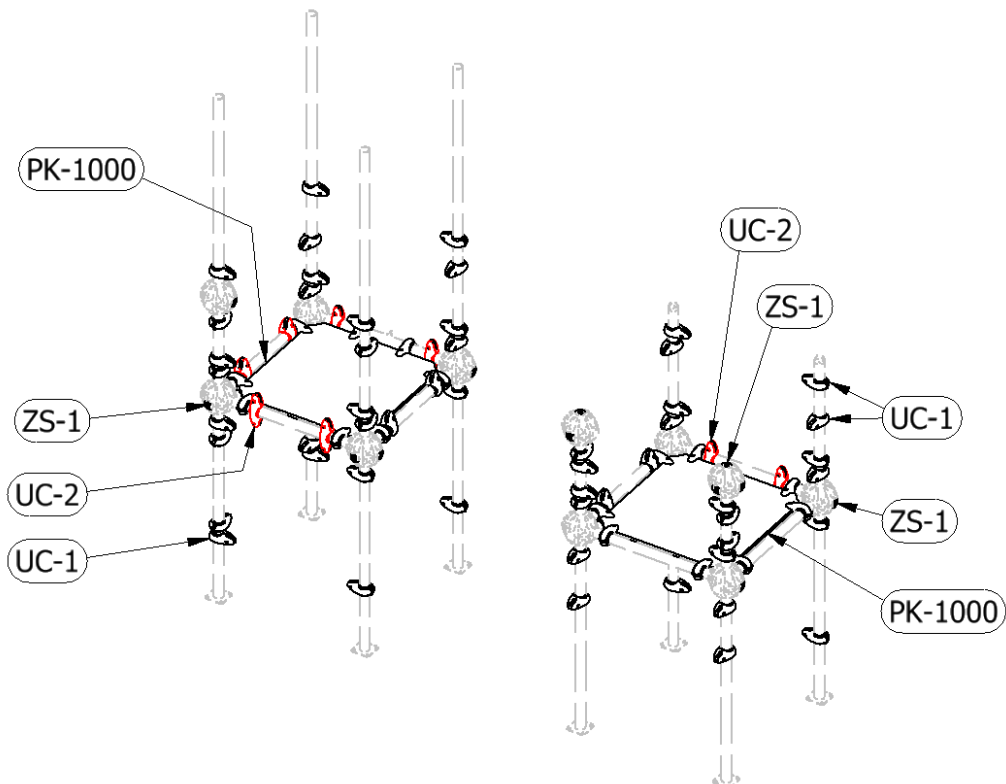

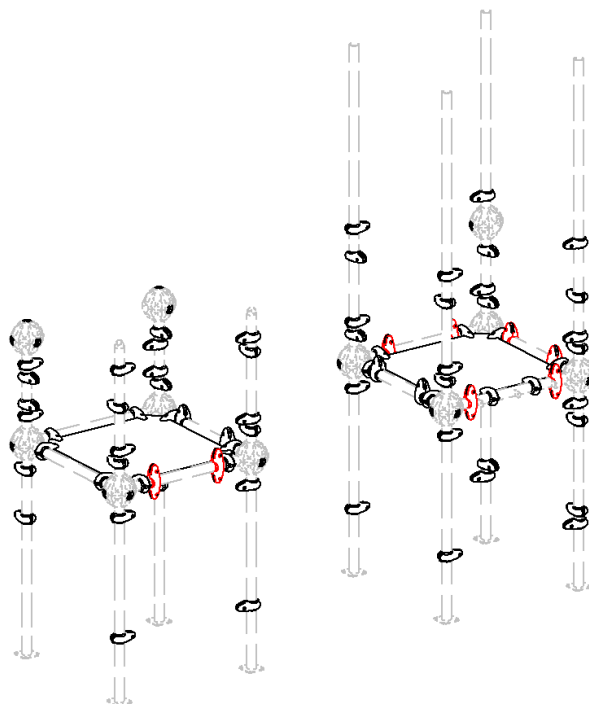

Zalecane wstępne nałożenie uchwytów (bez dokręcania)
Recommended initial assembly of holders (without tightening)

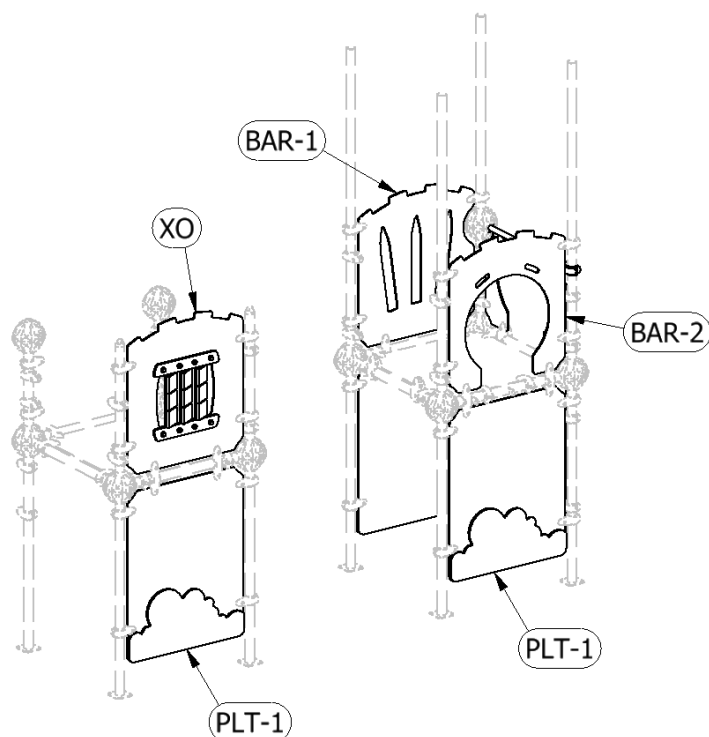

Zwrócić szczególną uwagę na rozstaw otworów montażowych w płytach PLT-1
Pay attention to the mounting holes in the boards PLT - 1

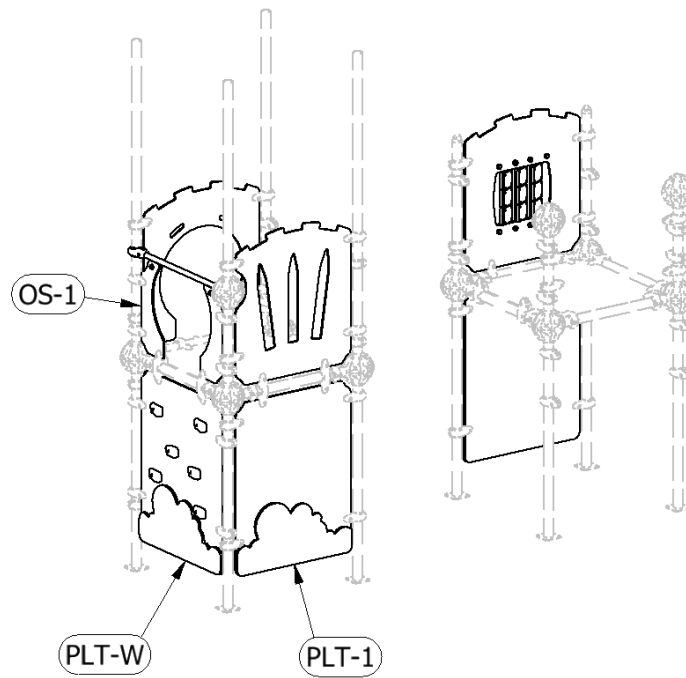

8. Podzespoły Components

