

INSTRUKCJA MONTAŻU INSTALLATION INSTRUCTION

Wydanie <i>Edition</i>	02
Data <i>Date</i>	30-07-2024

BUJAKI KUBEŁKOWE BUCKET SPRINGERS

Numer katalogowy
catalogue number **85501 - 85569**











1. Informacje techniczne *Technical information*

Grupa wiekowa <i>User age</i>	do 12 lat <i>up to 12 y.o.</i>
Maksymalna wysokość swobodnego upadku <i>Max. free fall height</i>	0,5 m
Największa część <i>Largest part</i>	Korpus <i>Body</i>
Wymiary największej części <i>Largest part dimensions</i>	~ 1 x 0,7 x 0,4 m
Masa największej części <i>Largest part weight</i>	50 kg
Masa największego fundamentu <i>Largest foundation weight</i>	30 kg
Zgodność z normami <i>Accordance with standards</i>	EN 1176-1 EN 1176-6

2. Wykaz narzędzi

Tools list

3. Wykaz części

Parts list

										
B300x4	Szt. Pcs	2	Korpus - komplet	Szt. Pcs	1					

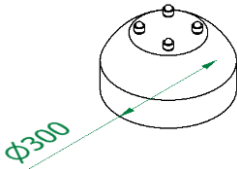
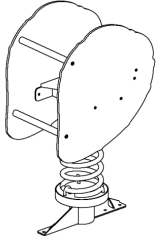
4. Fundamenty i powierzchnia zderzenia

Foundations and impact area

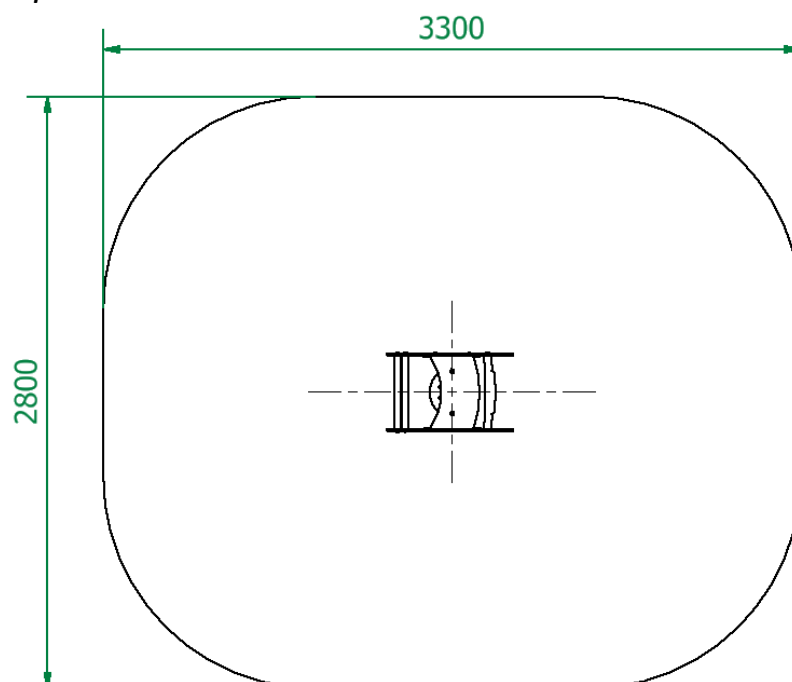

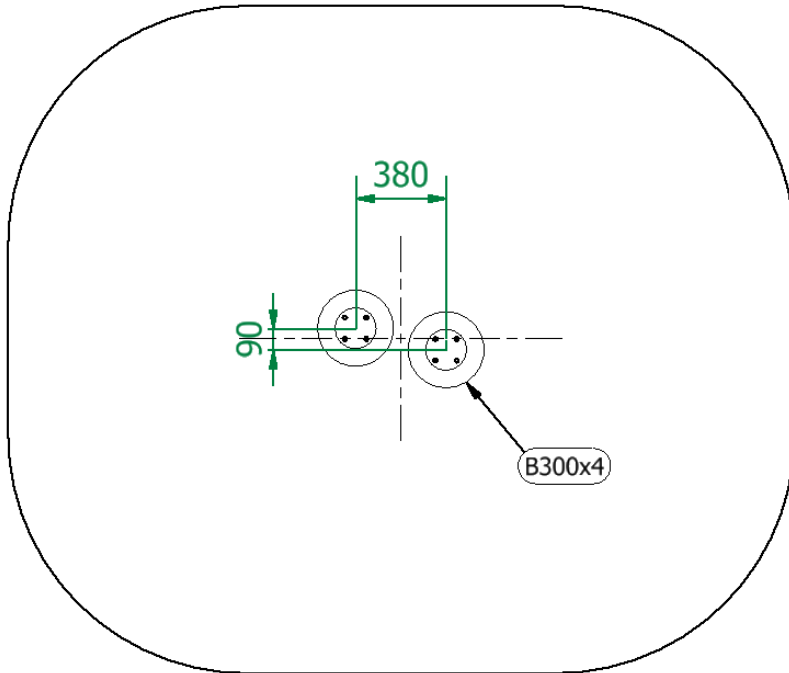

NUMER/NUMBER	SZT./PCS
B300x4	2

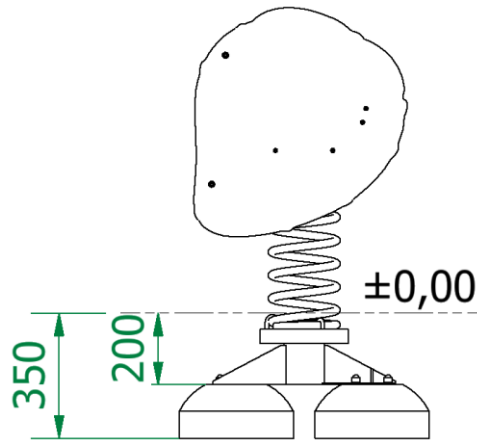

5. Urządzenie
Equipment

